

Catalogue 2019/2020

-  Clasps and Bars
-  Orthodontics
-  CA® CLEAR ALIGNER
-  CAD / CAM
-  Dental Sleep Medicine
-  Pressure Moulding Technique
-  Laboratory Equipment

Contents

Clasps and bars

N-Clasp	18	T-Clasp	19	SCHEU-Anchor	20
N-BI-Form-Clasp	18	TK-Clasp	19	PROFI Bar	21
NK-Clasp	18	J-Clasp	19	Jaw fracture splint	21
O-Clasp	18	J-Clasp oblique	20	Lingual bar	21
OK-Clasp	18	JM-Clasp	20		

Orthodontics

SCHEU-Anchor	24	VECTOR® screws and accessories	31–37	Hinge 44 kit	45
Adams Clasp	24	STEADY-RESIN	38–40	Fastening elements with retention	45
Triangle Clasp	24	Mica	40	Face bow polished	46
Arrow Clasp	25	RESIMIX®	40	ORTHOFIT® Anatomic	46
Coffin spring	25	3D Model insulation	41	Activator tubes	45
Frontal guiding bars acc. to Hinz	25	Orthodontic insulating agent	41	Activator tubes acc. to Teuscher	45
U-Bar acc. to Karwetzky	25	Metal spray nozzles	41	Silicone tube	47
MENZANIUM®	26	Spray bottle	41	Symmetry measurement gauge	47
CHROMIUM	27	Set-Up technique	42–43	Angle tester acc. to Adamik	47
Quad Helix	28	BLUE-BLOKKER®	42	Positioning aid	47
Lingual/palatal sheath	28	Hinge system acc. to Herbst	44	CETRON®	48–49
CARAT® Wire bending pliers	29–30	Fastening elements for Herbst appliance	44	Retainer boxes	49
Ortho arch bender	30	Distance rings	44		

// CA® CLEAR ALIGNER

CA® SMART 2D version 4.0	54	TFA-Kit acc. to Dr. Echarri	58	CA® Travel Case	65
CA® CHECKER	54	CA® TIP pliers	59–60	CA® FLASH	65
CA® Photo support 4.0 and accessories	54–55	CA® Strip Opener	61	CA® Grinding set	66
CA® Foil	56	CA® Stripping Tool	61	CA® Platstic buttons	66
CA® Retention foil pd	56	Stainless steel holder	62	CA® Cyano Veneer Fast	66
CA® Arch CHROMIUM	57	ECHARRI PST Set	62	CA® Pipettes	66
VECTOR® 30	57	CA® Gauge	62	CA® Coloured pencils	66
VECTOR® 40 acc. to Prof. Hinz	57	CA® POWER GRIP	63–64	Splint Remover	67
VECTOR® 45 acc. to Prof. Hinz	58	CA® Splint bags	65	ECHARRI Template kit	67
CA® Distalizer kit acc. to Dr. Echarri	58	CA® Splint case for patients	65	CA® literature	67

// CAD / CAM

Asiga MAX™	70	3D Model insulation	75	IMPRIMO® LC Denture	78
Asiga MAX™ LCD	71	IMPRIMO® LC Model	76	IMPRIMO® LC Temp	78
Asiga MAX™ Tray	71	IMPRIMO® LC Splint	76	IMPRIMO® LC Temp It	79
Asiga PRO HD	72	IMPRIMO® LC Impression	76	IMPRIMO® LC MJF	79
Asiga PRO 4K	73	IMPRIMO® LC IBT	77	OnyxCeph3™ CA® SMART 3D	80 – 81
IMPRIMO® Clean	74	IMPRIMO® LC Cast	77	DURASPLINT® flex	81
IMPRIMO® Cleaning Liquid	74	IMPRIMO® LC Gingiva	77		
IMPRIMO® Cure	75	IMPRIMO® LC Try-In	78		

// Dental Sleep Medicine

IST® Kit HF 9	84	dreamTAP™	88	Bite Fix® One	92
Telescopes	84	TAP® PAP	88	GEORGE GAUGE™ bite registration set	93
IST® fastening elements and positioning aid	84–85	TAP® PAP Lower Tray	88	AM Aligner	93
OPM Kit	85	myTAP™	89	Occlusion trainer	93
TAP® Standard Kit	86	TAP® Splint case for patients	89	CLEAR-BLOKKER®	94
TAP®-T Kit	86	TAP®-T Mounting device	89	SD-Cyano Veneer Fast	94
TAP®-T Reverse Kit	87	TAP®-T Matrix	89	SD-Pipettes	94
TAP®-T Starter-Set	87	TAP® components	90–91	Activation key	94
TAP®-T Reverse Starter-Set	87	Bite Fix®	92	CETRON®	95
		Bite Fix® Scan	92		

Pressure moulding technique

Pressure moulding material					
BIOCRYL® C	98	HARDCAST®	107	Pellet cover	113
BIOCRYL® Form X	98	ISOFOLAN®	108	Pellet brush	113
DURAN®	99	Spacer foil	108	Model platform	113
DURAN®+	99	Skin packaging	108	Heating support	113
DURAN®+ A2 pd	100	Coating foil	108	SD-Foil scissors A	114
DURAN®+ white pd	100	Accessories		SD-Foil scissors B	114
DURASOFT® pd	101	BLUE-BLOKKER®	109	Finishing set	114
DURASOFT® blue pd	101	CLEAR-BLOKKER®	109	LC-Bur	115
DURASOFT® seal	101	Cannula	109	Finishing bur	115
BIOPLAST®	102	SIL-KITT	109	HM-Tricutter fine	115
BIOPLAST® bleach	102	Blocking-out putty	110	HM-Carbide cutter	115
BIOPLAST® Color	103	BIOPLAST® Insulating agent	110	Cutting bur	115
BIOPLAST® Multicolor	104	BIOCRYL® Resin	110	OSAMU Polisher	116
BIOPLAST® XTREME	104	DURASPLINT®	110	POLYFIX	116
BIOPLAST® XTREME Kit	105	DURASPLINT® flex	111	BIOPERM® Trimmer	116
BIOPLAST® XTREME PRO Kit	105	DURASPLINT® LC	111	DIMO®	116
BRUX CHECKER® acc. to Prof. Sato	105	LC Primer	112	DIMO®PRO	117
IMPRELON®	106	LC Insulation	112	DIMO®PRO SLIM	117
IMPRELON® S pd	106	OSAMU-Bond	112	SD-Polishing brush	117
OSAMU-Retainer® Kit	106	Impression tray handles	112	SD-Polishing mop for high gloss	117
COPYPLAST®	107	Foam discs	112	SD-Felt wheel	117
COPYPLAST® C	107	Stainless steel pellets	113	SD-Polishing paste	117

Laboratory equipment

Asiga MAX™	120	LC-6 Light Oven	125	Model holder	128
Asiga MAX™ LCD	121	LC-Mini Light	125	Parallelometer	128
Asiga MAX™ Tray	121	Metal support for LC Mini Light	125	Split-Fixator	129
Asiga PRO HD	122	BIOSTAR®	126	Hinge fixator	129
Asiga PRO 4K	123	BIOSTAR® Protection cover	126	Mounting rails	129
IMPRIMO® Clean	124	MINISTAR S®	127		
IMPRIMO® Cure	124	MINISTAR S® Protection cover	127		

Appendix

Indication chart on pressure moulding applications	130-131	Technical properties of IMPRIMO® LC resins	132-133	Material lists and measuring units	135
		Expansion parameters of VECTOR® screws	134	Product index by REF number	136-138



Klaus-Peter Mudlaff
CEO
smile-dental-Handelsgesellschaft mbH



Dr. Yong-min Jo
Founder and CEO
CA DIGITAL GmbH



Christian Scheu
CEO SCHEU-DENTAL GmbH
Founder and CEO
CA DIGITAL GmbH



Dr. Martin Klare
CEO
pro3dure medical GmbH



Products are changing, values remain.

Last year I was struck by a sudden insight: **SCHEU-DENTAL will soon turn one hundred.** What began in 1926 as a small family company in the dental practice of my grandfather, has survived almost a century. What makes us different from other companies in this fast-paced, result-oriented time? They, too, are able to find well-trained employees, to create a motivating work environment and to provide their customers with a top quality service.

I think it not only needs to be the product, the staff or the quality but rather a sum of many parts to ensure a company's future across successive generations. It needs economic success, which is distributed in social responsibility and reinvested with entrepreneurial foresight. It takes values that are preserved as a tradition just as much as it takes rebellion, questioning outdated standards and recognising opportunities in new and partially disruptive business models.

So, by now, SCHEU-DENTAL is no longer just the family enterprise, but the sum of the company's network, covering traditional dental technology and innovative orthodontics as well as cutting-edge 3D technology. My experience in the SME sector has taught me one thing: Together, we can achieve more. This applies to our partners and subsidiaries as well as to you, our customers.

So let's continue our mutual success – we are looking forward to many more exciting years by your side!

Yours sincerely,
Christian Scheu



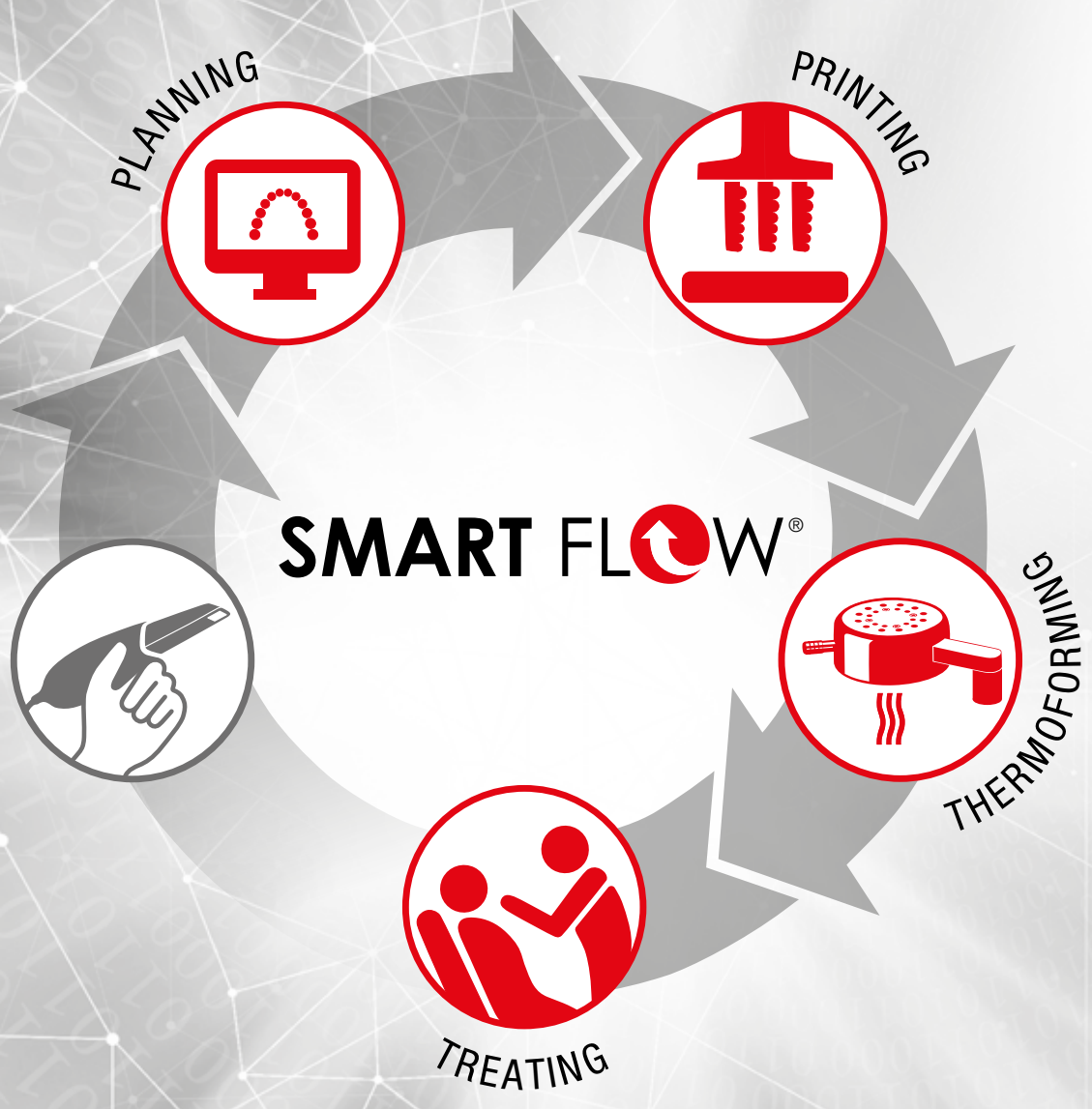

Join us in the digital workflow.

For years, we have been observing that clinical and dental processes in orthodontics are about to change fundamentally: what begins with intra-oral scanning and continues with virtual diagnostic assessment and digital treatment planning for aligners, is completed by the additive manufacturing process before the actual therapy on the patient closes the circle.

The dynamics of replacing proven manual working steps by digital ones fascinates us, as it is about to change our professional world significantly and offers possibilities to develop new competencies. Our vision is to contribute to and to shape this exciting development so that you, the user, can benefit from the efficient work processes that are made possible by these new technologies at manageable risk.

Our approach is simple: new technologies involve considerable investments for all participants, which are always associated with entrepreneurial uncertainties. So why not spread the risks over more than one shoulder and address them step by step? **SMART FLOW** offers you the option to complement proven treatment approaches by innovative technologies at your own pace and according to your personal preferences. You can access the digital workflow at any point, determine the individual level of your digitisation for yourself or have digital planning and production provided externally by our service company, CA DIGITAL. This enables you to access innovative technologies and treatment solutions without having to manage digital manufacturing in your own lab.

Join us in the digital workflow. We accompany you as long as you want us to, step by step!

SMART FLOW



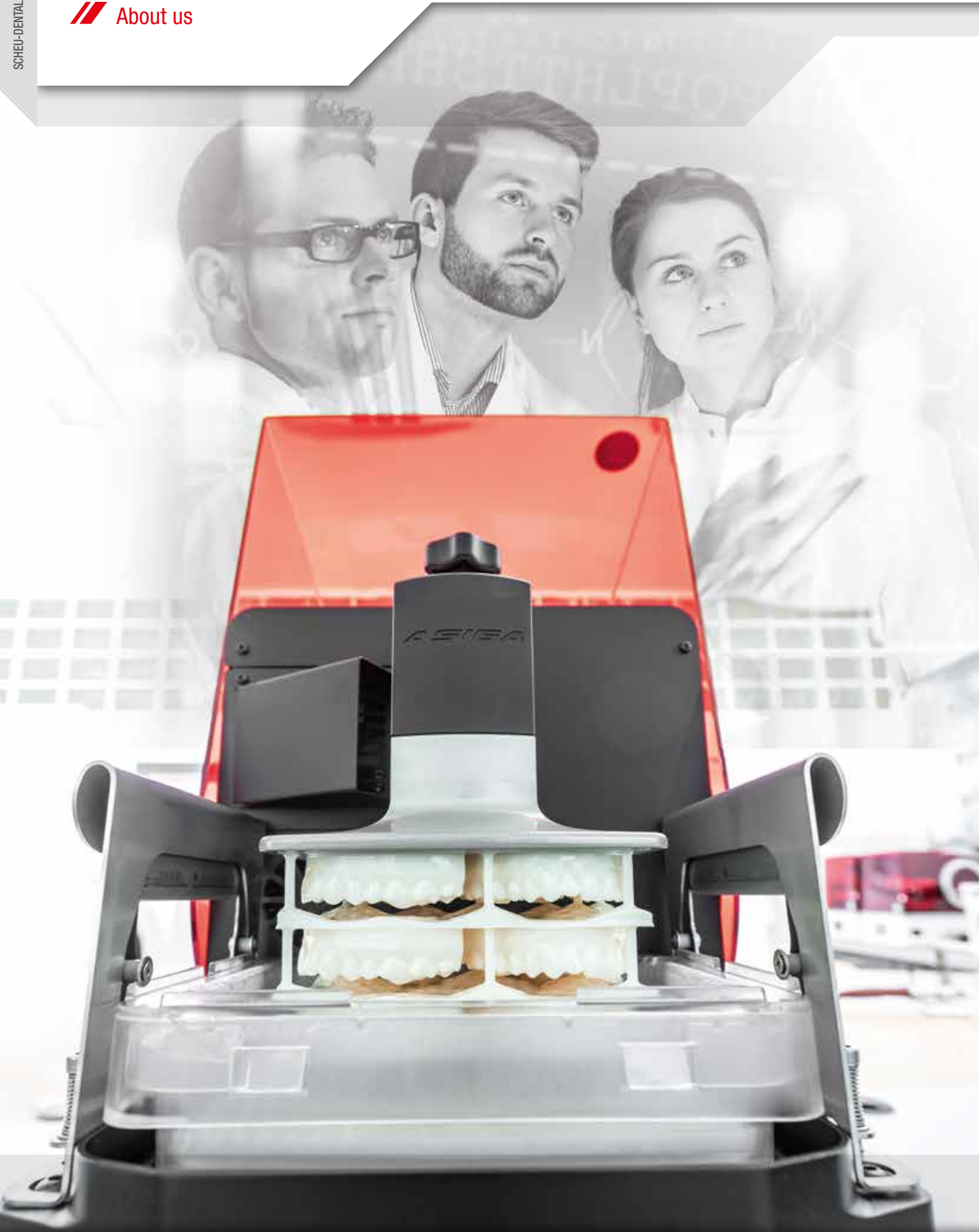

You have to have a vision to shape the future.

At our research and development department, we come up with clever ideas designed to lighten the daily workload of the dental laboratory and practice. Some of these ideas may have no future, but others may already enrich your daily work life like the research into enhanced resins, the optimisation of the user-friendliness of our thermoforming devices or the development of innovative products for the treatment of sleep-related breathing disorders or malocclusion.

Still, other ideas may even have the potential to change your future working life fundamentally. Together with **CA DIGITAL**, we offer you the complete range of digital services and products incorporated in a smart workflow: The 3D printer **ASIGA MAX™** and our **IMPRIMO® LC resins**, specifically designed for 3D printers with a 385 nm light source, allow additive manufacturing for a variety of dental indications, from working models to occlusal splints.

What all our ideas have in common is that they are accompanied by excellent service. Our field technicians show you how to operate our thermoforming machines, our application technicians in the lab are there to help you with questions on our products, our scientific employees for the development of new thermoforming materials assist you with any question you may have around these materials and our experts in sleep medicine are pleased to consult you on manufacturing anti-snoring devices for patients with a problematic occlusion. Last but not least, our 3D printing application technicians take care of your requests concerning digital technologies via the phone, TeamViewer or an on-site-appointment. If you have questions about a product, you should talk to someone who works with it every day or even developed it.

Shape the future realising our visions!

**We are there to
assist you!**



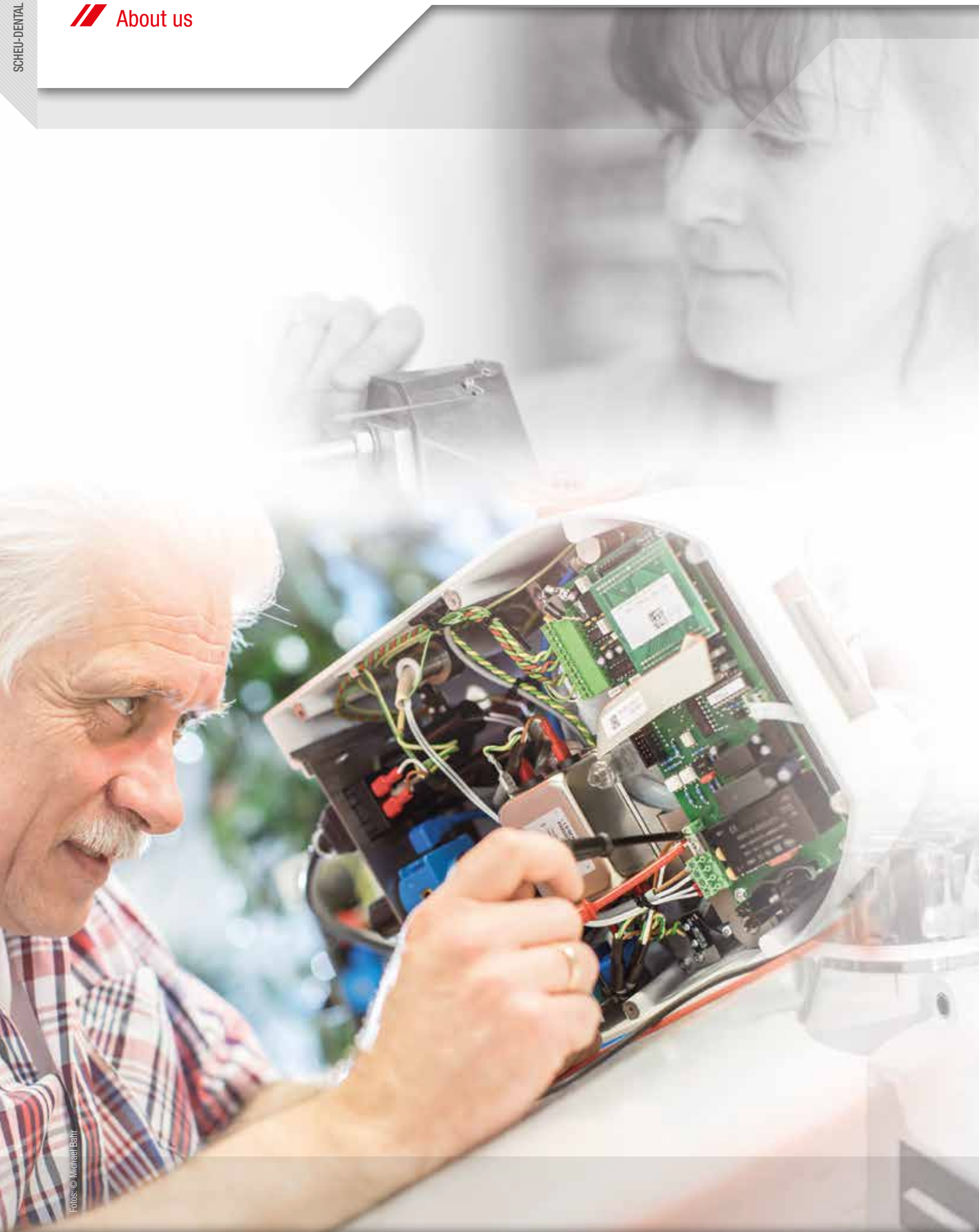

Fotos: © Michael Baur

Great attention to detail – even to the smallest part.

The realisation of complex precision constructions requires dexterity and experience. Therefore, many parts at SCHEU-DENTAL are still manufactured by hand, as this is the only way to ensure the highest possible quality of the precision mechanical parts. The staff at our site makes sure that the company never deviates from these quality standards – regular product controls according to the most recent certification standards included.

Thanks to this enthusiasm and a love for detail, we are able to establish ourselves as a leader in the field of dental pressure moulding and to participate in shaping dental technologies around the world. A confirmation of our work which is rich in tradition, that we are particularly proud of, especially since our products demonstrate their quality today in practices and laboratories in over 100 countries.

**Impressions from
our production:**

Have a look
behind the scenes!





Fotos: © Michael Bahr

Service makes the difference.

It has always been our concern to give you practical advice, combined with a sound basis in specialist knowledge, whether it comes to personal commissioning, your technical devices or answering practical questions about their application. Our co-workers in the sales and service departments are happy to support you with qualified advice.

This goes beyond your actual purchase: for some years now, our **SCHEU-ACADEMY** regularly offers training courses and seminars for dentists and technicians including certification courses on CA® CLEAR ALIGNER and TAP®, as well as pressure moulding workshops and application courses around digital orthodontics. You get to learn, by practical applications and in small groups, how to achieve even more professional results in the future.

In addition, our field technicians offer **dental workshops** at your trading partners where you can be trained in pressure moulding techniques, bleaching and 3D printing.

Explore our extensive offer on advanced training for dental labs and practices at www.scheu-dental.com/en/scheu-academy or make an appointment with our field service – we look forward to seeing you!

Watch our training
videos online:





Clasps and bars

For us at SCHEU-DENTAL continuity and quality go hand in hand.

We have been manufacturing clasps for more than 90 years.

Based on that experience, our range of clasps and bars has become a benchmark. Made of high-grade stainless steel alloys with excellent resistance to oral conditions, fabricated by cold forming, from one

piece without soldering connections and with highly-polished surface. Our clasps are of excellent elasticity and stability – your patients can trust you.

Clasps.....	18	Bars.....	21
-------------	----	-----------	----

Clasps

Our clasps are made by cold forming of a stainless steel alloy (material DIN no. 1.4301) with excellent resistance to oral conditions. Highly-polished surface, from one piece without solder connections for optimum elasticity and stability.



N-Clasp

// Ø 0.9 mm	1009.1 10 pieces	1009.2 100 pieces
// Ø 1.0 mm	1010.1 10 pieces	
// Ø 1.2 mm	1011.1 10 pieces	

CE



N-BI-Form-Clasp

// Ø 0.9/1.2 mm	1012.1 10 pieces
-----------------	----------------------------

CE

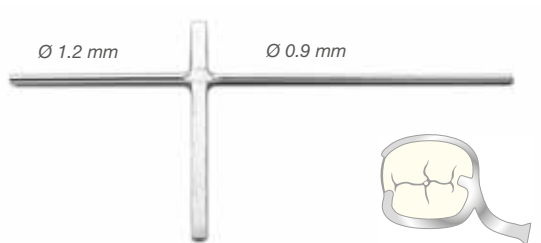

NK-Clasp

// Ø 0.8 mm	1013.1 10 pieces	1013.2 100 pieces
-------------	----------------------------	-----------------------------

CE

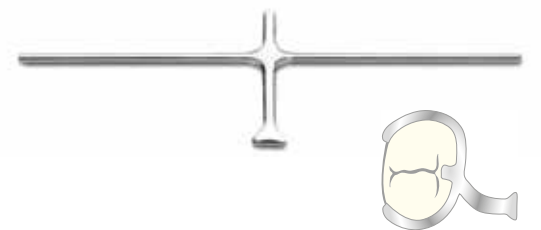

O-Clasp

// Ø 0.9 mm	1002.1 10 pieces	1002.2 100 pieces
// Ø 1.0 mm	1003.1 10 pieces	

CE



OK-Clasp

// Ø 0.8 mm	1007.1 10 pieces
-------------	----------------------------

CE



T-Clasp

// Ø 0.9 mm

1026.1
10 pieces

// Ø 1.0 mm

1027.1
10 pieces

CE

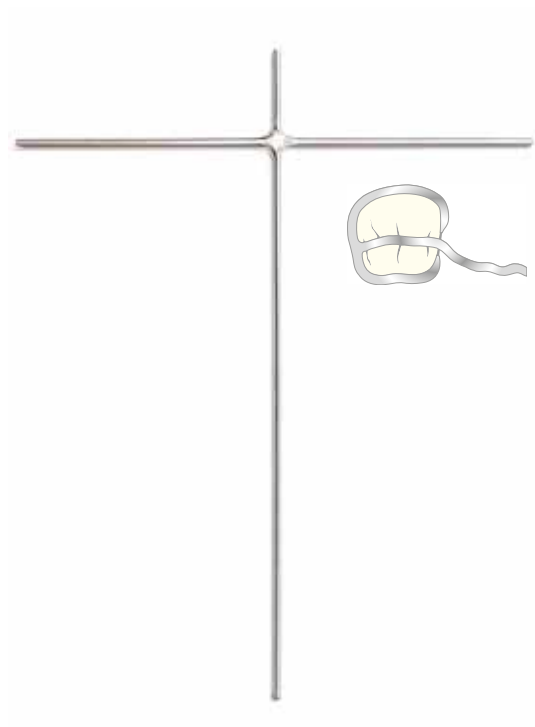

TK-Clasp

// Ø 0.9 mm

1029.1
10 pieces

1029.2
100 pieces

// Ø 1.0 mm

1030.1
10 pieces

1030.2
100 pieces

CE

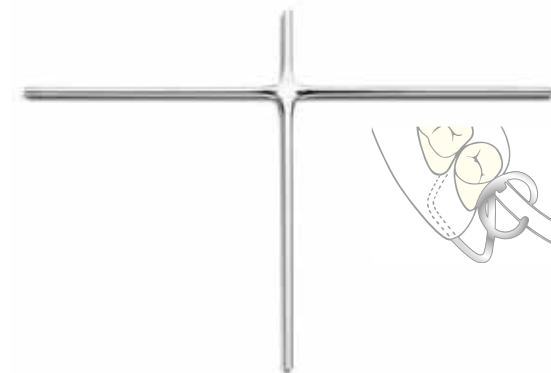

J-Clasp

// Ø 0.8 mm

1017.1
10 pieces

1017.2
100 pieces

// Ø 0.9 mm

1018.1
10 pieces

1018.2
100 pieces

// Ø 1.0 mm

1019.1
10 pieces

1019.2
100 pieces

// Ø 1.1 mm

1047.1
10 pieces

CE

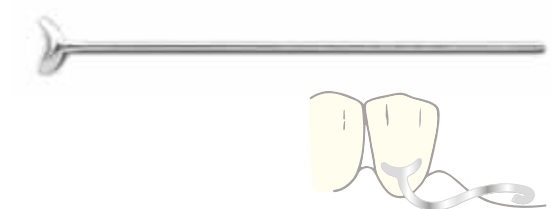

J-Clasp oblique

∕ ∅ 0.8 mm in pairs (5 / 50 left and 5 / 50 right)	1020.1 10 pieces	
∕ ∅ 0.9 mm in pairs (5 / 50 left and 5 / 50 right)	1021.1 10 pieces	1021.2 100 pieces
∕ ∅ 1.0 mm in pairs (5 / 50 left and 5 / 50 right)	1022.1 10 pieces	1022.2 100 pieces
∕ ∅ 1.1 mm in pairs (5 left and 5 right)	1048.1 10 pieces	

CE

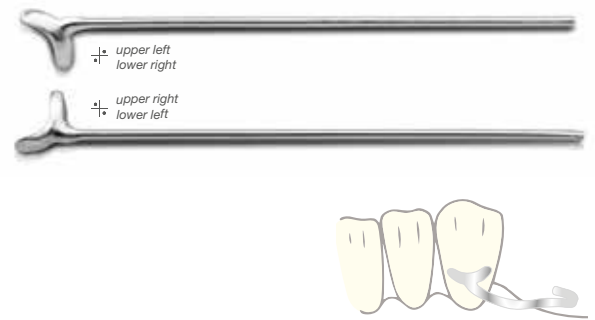

JM-Clasp

∕ ∅ 1.2 mm	1023.1 10 pieces
------------	----------------------------

CE

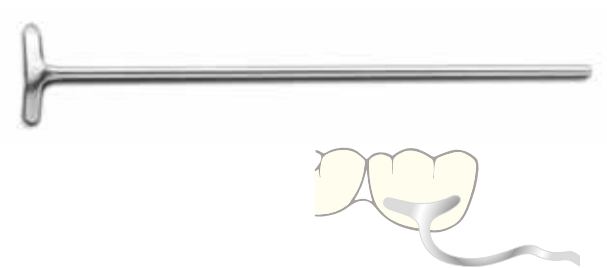

SCHEU-Anchor

Unique retention and spring force! SCHEU-Anchors consist of stainless steel alloys (material DIN no. 1.4301) with excellent resistance to corrosion and oral conditions.

∕ ∅ 0.6 mm	2048.1 10 pieces	2048.2 100 pieces	
∕ ∅ 0.7 mm	2049.1 10 pieces	2049.2 100 pieces	2049.3 1000 pieces
∕ ∅ 0.8 mm	2050.1 10 pieces	2050.2 100 pieces	2050.3 1000 pieces
∕ ∅ 0.9 mm	2051.1 10 pieces	2051.2 100 pieces	2051.3 1000 pieces
∕ ∅ 1.0 mm	2052.1 10 pieces	2052.2 100 pieces	
∕ ∅ 1.2 mm	2053.1 10 pieces	2053.2 100 pieces	

CE

Bars

PROFI Bar

Made of stainless steel alloy (material DIN no. 1.4303) with excellent resistance to oral conditions and highly-polished surface. From one piece without solder connections for optimum elasticity and stability.

// curved, length 80 mm	1039.1 10 pieces
// straight, length 80 mm	1040.1 10 pieces

CE

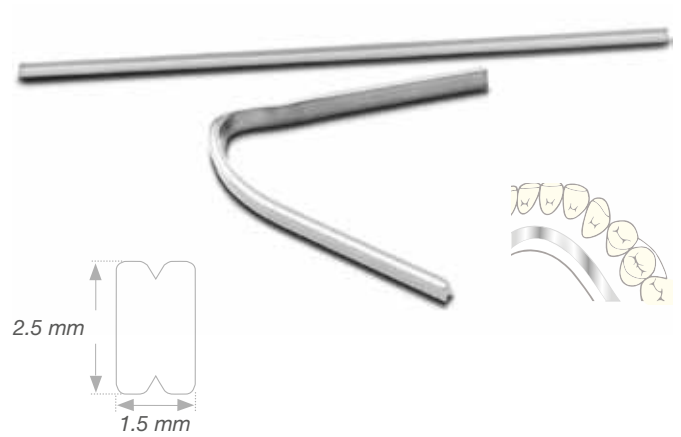

Jaw fracture splint

Made of stainless steel alloy (material DIN no. 1.4301) with excellent resistance to corrosion and oral conditions, with 20 buttons. MRI incompatible.

// hard, Ø 1.0 mm	1038.1 10 pieces
// soft, Ø 1.0 mm	1049.1 10 pieces

CE



Lingual bar

Elliptical, hard stainless steel profile (material DIN no. 1.4310), anatomically curved with stamped retentions.

// curved, length 60 mm	1051.1 10 pieces
// curved, length 70 mm	1052.1 10 pieces
// curved, length 80 mm	1053.1 10 pieces

CE

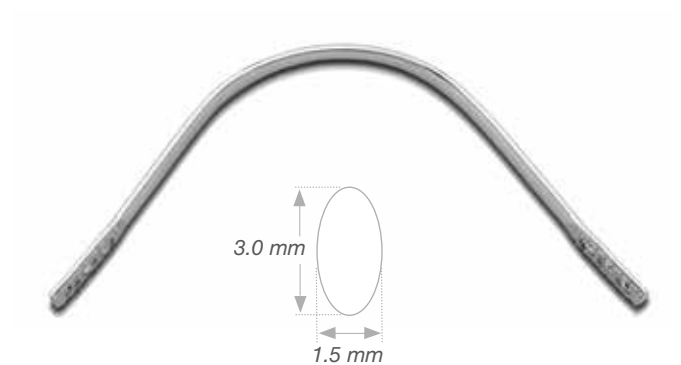



Orthodontics

Our products are still unsurpassed.

Quality is not a question of size. End of the 1950ies, our first orthodontic product was the SCHEU-Anchor – a retention element, still unsurpassed in terms of quality, workmanship and

spring force. Today our orthodontic line is supplemented and enhanced by innovative products such as VECTOR® expansion screws and the CA® CLEAR ALIGNER splint therapy.

Clasps and wires	24	Acrylics technique.....	38
CARAT® Wire bending pliers	29	Set-up technique	42
VECTOR® screws	31	Hinges and face bows	44
Accessories for VECTOR® screws.....	37	Accessories	47

Clasps and wires

Learn more:



SCHEU-Anchor

Unique retention and spring force! SCHEU-Anchors consist of stainless steel alloys (material DIN no. 1.4301) with excellent resistance to corrosion and oral conditions.

// Ø 0.6 mm	2048.1 10 pieces	2048.2 100 pieces	
// Ø 0.7 mm	2049.1 10 pieces	2049.2 100 pieces	2049.3 1000 pieces
// Ø 0.8 mm	2050.1 10 pieces	2050.2 100 pieces	2050.3 1000 pieces
// Ø 0.9 mm	2051.1 10 pieces	2051.2 100 pieces	2051.3 1000 pieces
// Ø 1.0 mm	2052.1 10 pieces	2052.2 100 pieces	
// Ø 1.2 mm	2053.1 10 pieces	2053.2 100 pieces	

CE

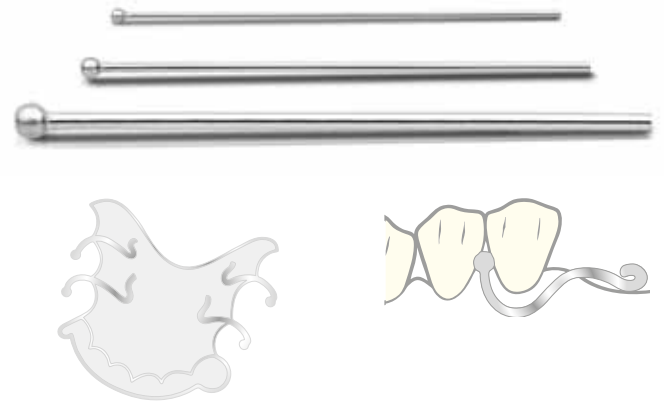

Adams Clasp

Modified form for optimised retention and easy adjustment. Made of the nickel-free MENZANIUM® alloy – nickel trace elements of 0 to 0.2% are procedurally possible.

// Ø 0.7 mm, width 6 mm	2104.1 10 pieces	2104.2 100 pieces
// Ø 0.7 mm, width 7 mm	2105.1 10 pieces	2105.2 100 pieces
// Ø 0.7 mm, width 8 mm	2106.1 10 pieces	2106.2 100 pieces
// Ø 0.7 mm, width 9 mm	2107.1 10 pieces	2107.2 100 pieces
// Ø 0.7 mm, width 10 mm	2108.1 10 pieces	2108.2 100 pieces
// Ø 0.7 mm, width 11 mm	2109.1 10 pieces	2109.2 100 pieces

CE

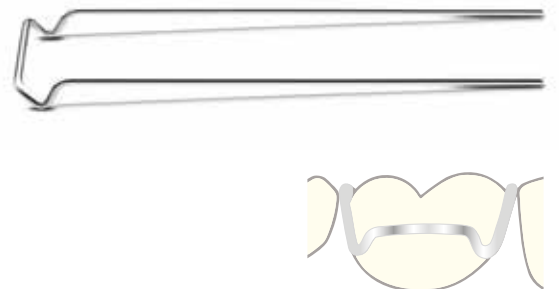

Triangle Clasp

Made of the nickel-free alloy MENZANIUM®, with high-gloss polished surface. Excellent elasticity and breaking strength. Nickel trace elements from 0 to 0.2% are procedurally possible.

// Ø 0.7 mm	2288.1 100 pieces	2288.2 1000 pieces
// Ø 0.8 mm	2322.1 100 pieces	2322.2 1000 pieces

CE

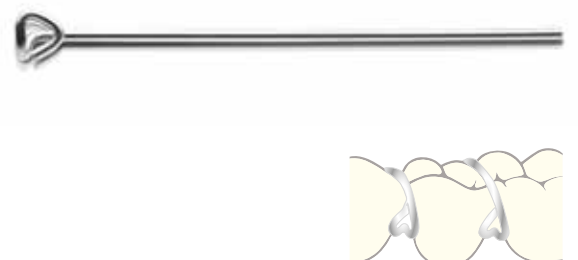

Arrow Clasp

Made of the nickel-free alloy MENZANIUM®, with high-gloss polished surface. Excellent elasticity and breaking strength. Nickel trace elements from 0 to 0.2% are procedurally possible.

// Ø 0.7 mm

2055.2
100 pieces

// Ø 0.8 mm

2056.2
100 pieces

CE

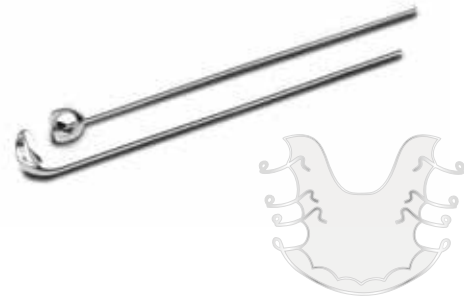

Coffin spring

Made of the nickel-free MENZANIUM® alloy – nickel trace elements of 0 to 0.2% are procedurally possible.

// Ø 1.2 mm, length 11 mm

2419.1
10 pieces

2419.2
100 pieces

CE



Frontal guiding bars acc. to Hinz

For treatment of Angle Class II cases (lower jaw retrusion/distal occlusion) by means of bimaxillary appliances as well as for bilateral upper jaw expansion in growing children using an expansion screw. Made of the nickel-free alloy MENZANIUM® – nickel trace elements from 0 to 0.2 % are procedurally possible.

// Ø 1.2 mm, length 14 mm

2329.1
5 pairs

2329.2
50 pairs

// Ø 1.2 mm, length 18 mm

2330.1
5 pairs

2330.2
50 pairs

CE



U-Bar acc. to Karwetzky

Functional orthodontic appliance enabling the lower jaw to move in the required position depending on the type (1 - 3). U-bars acc. to Karwetzky consist of stainless steel alloys with excellent resistance to corrosion and oral conditions.

// U-Bar acc. to Karwetzky

2118.1
5 pairs

2118.2
50 pairs

CE



MENZANIUM®

MENZANIUM® is a nickel-free stainless steel alloy, fabricated in a patented high pressure melting process replacing allergenic components of nickel by manganese and nitrogen. Compared to conventional stainless steel wires, corrosion resistance and breaking strength are increased. Wire is available in two versions hard (1400-1600 N/mm²) and spring hard (1800-2000 N/mm²). Processing by joining techniques such as laser-welding and welding. Measurements, tolerances and quality in accordance with DIN EN ISO 15841.

Learn more:



MENZANIUM® Coil wire

Diamond drawn and high gloss polished, available as laboratory coil (10-50 m wire length) or clincial coil (500 g / 58-330 m wire length).

// Ø 0.7 mm / .028 inch, hard	8453.1 30 m	8453.2 500 g
// Ø 0.8 mm / .032 inch, hard	8454.1 20 m	8454.2 500 g
// Ø 0.9 mm / .036 inch, hard	8455.1 10 m	8455.2 500 g
// Ø 1.0 mm / .040 inch, hard	8456.1 10 m	
// Ø 0.5 mm / .020 inch, spring hard	8459.1 50 m	
// Ø 0.6 mm / .024 inch, spring hard	8460.1 40 m	8460.2 500 g
// Ø 0.7 mm / .028 inch, spring hard	8461.1 30 m	8461.2 500 g
// Ø 0.8 mm / .032 inch, spring hard	8462.1 20 m	8462.2 500 g
// Ø 0.9 mm / .036 inch, spring hard	8463.1 10 m	8463.2 500 g
// Ø 1.0 mm / .040 inch, spring hard	8464.1 10 m	8464.2 500 g
// Ø 1.2 mm / .048 inch, spring hard	8466.1 10 m	8466.2 500 g

Nickel trace elements of 0-0.2% are procedurally possible.



MENZANIUM® Wire rods

Crosscut and aligned, in packages of 500 g.

// Ø 0.7 mm / .028 inch, length 75 mm, hard	8480.1 500 g
// Ø 0.7 mm / .028 inch, length 150 mm, hard	8482.1 500 g
// Ø 0.6 mm / .024 inch, length 75 mm, spring hard	8478.1 500 g
// Ø 0.7 mm / .028 inch, length 75 mm, spring hard	8467.1 500 g
// Ø 0.7 mm / .028 inch, length 150 mm, spring hard	8468.1 500 g
// Ø 0.8 mm / .032 inch, length 150 mm, spring hard	8469.1 500 g
// Ø 0.8 mm / .032 inch, length 200 mm, spring hard	8470.1 500 g
// Ø 0.9 mm / .036 inch, length 150 mm, spring hard	8471.1 500 g
// Ø 0.9 mm / .036 inch, length 200 mm, spring hard	8472.1 500 g
// Ø 1.0 mm / .040 inch, length 200 mm, spring hard	8473.1 500 g

Nickel trace elements of 0 - 0.2% are procedurally possible.

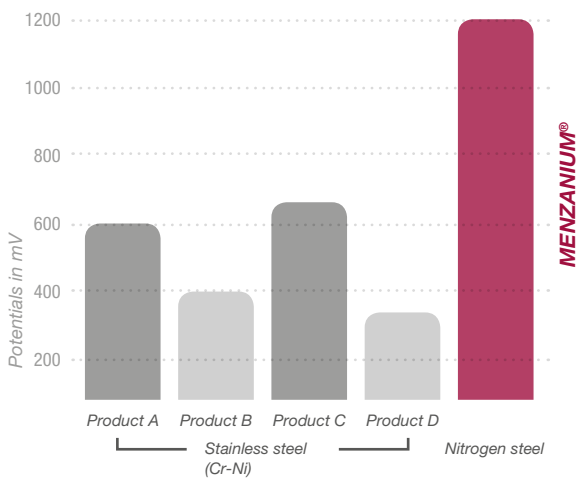

Breakdown potential for wires from the group of iron alloys

Electrochemical study of corrosion properties of orthodontic auxiliaries in artificial saliva (reference electrode Ag / AgCl, feed rate: 1 m V/sec).

M. Neuhöfer: "Experimental Dentistry", dissertation 1993, University of Freiburg, head: Prof. Dr. H. F. Kappert

CE

CHROMIUM

Wire made of chrome nickel steel (DIN material no. 1.4310), available in two versions hard (1400-1600 N/mm²) and spring hard (1800-2000 N/mm²). Processing by joining techniques such as laser-welding and welding. Measurements, tolerances and quality in accordance with DIN EN ISO 15841.

Learn more:



CHROMIUM Coil wire

Diamond drawn and high gloss polished, available as laboratory coil (10-50 m wire length) or clinical coil (500 g / 26-324 m wire length).

// Ø 0.5 mm / .020 inch, hard	8323.1	
	50 m	
// Ø 0.6 mm / .024 inch, hard	8324.1	
	40 m	
// Ø 0.7 mm / .028 inch, hard	8325.1	8325.2
	30 m	500 g
// Ø 0.8 mm / .032 inch, hard	8326.1	8326.2
	20 m	500 g
// Ø 0.9 mm / .036 inch, hard	8327.1	8327.2
	10 m	500 g
// Ø 1.0 mm / .040 inch, hard	8328.1	8328.2
	10 m	500 g
// Ø 1.1 mm / .044 inch, hard	8329.1	
	10 m	
// Ø 1.2 mm / .048 inch, hard	8338.1	
	10 m	
// Ø 1.5 mm / .059 inch, hard	8382.2	
	500 g	
// Ø 1.5 mm / .059 inch, hard	8383.2	
	500 g	
// Ø 0.5 mm / .020 inch, spring hard	8330.1	
	50 m	
// Ø 0.6 mm / .024 inch, spring hard	8331.1	8331.2
	40 m	500 g
// Ø 0.7 mm / .028 inch, spring hard	8332.1	8332.2
	30 m	500 g
// Ø 0.8 mm / .032 inch, spring hard	8333.1	8333.2
	20 m	500 g
// Ø 0.9 mm / .036 inch, spring hard	8334.1	8334.2
	10 m	500 g
// Ø 1.0 mm / .040 inch, spring hard	8335.1	8335.2
	10 m	500 g
// Ø 1.1 mm / .044 inch, spring hard	8336.1	8336.2
	10 m	500 g
// Ø 1.2 mm / .048 inch, spring hard	8339.1	8339.2
	10 m	500 g

CE



CHROMIUM Wire rods

Crosscut and aligned, in packages of 500 g.

// Ø 0.7 mm / .028 inch, length 100 mm, hard	8293.1
	500 g
// Ø 0.7 mm / .028 inch, length 150 mm, hard	8294.1
	500 g
// Ø 0.8 mm / .032 inch, length 150 mm, hard	8297.1
	500 g
// Ø 0.7 mm / .028 inch, length 75 mm, spring hard	8306.1
	500 g
// Ø 0.7 mm / .028 inch, length 100 mm, spring hard	8307.1
	500 g
// Ø 0.7 mm / .028 inch, length 150 mm, spring hard	8308.1
	500 g
// Ø 0.8 mm / .032 inch, length 150 mm, spring hard	8311.1
	500 g
// Ø 0.8 mm / .032 inch, length 200 mm, spring hard	8312.1
	500 g
// Ø 0.9 mm / .036 inch, length 150 mm, spring hard	8313.1
	500 g
// Ø 0.9 mm / .036 inch, length 200 mm, spring hard	8314.1
	500 g

CE



Quad Helix

Ready-made expansion arch from CHROMIUM wire (\varnothing 0.9 mm) for fixation at the upper molars in palatal sheaths. Available in straight and curved.

// size 1, straight sheath	8010.1 5 pieces
// size 1, curved sheath	8011.1 5 pieces
// size 2, straight sheath	8020.1 5 pieces
// size 2, curved sheath	8021.1 5 pieces
// size 3, straight sheath	8030.1 5 pieces
// size 3, curved sheath	8031.1 5 pieces

CE 0044

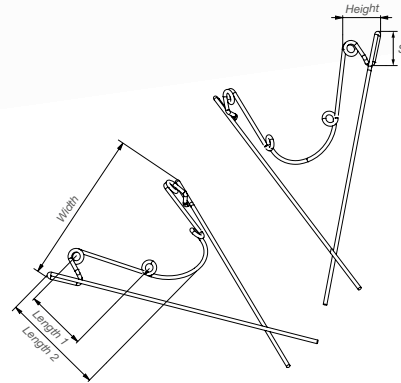

	straight			curved		
	8010 Size 1	8020 Size 2	8030 Size 3	8011 Size 1	8021 Size 2	8031 Size 3
Length 1	13	16	17.5	13	16	17.5
Length 2	25	27	29	25	27	29
Width	36	39	45	36	39	45
Height	9	9	9	10	10	10
S	5.5 + 1					

S = dimension sheath

Lingual/palatal sheath

Stainless steel sheaths for soldering or laser-welding on molar bands. Available in straight and curved.

// straight	8080.1 5 pieces
// curved	8081.1 5 pieces

CE 0044



CARAT® Wire bending pliers

Pliers made of high quality stainless steel alloy with exactly machined tool tips and precisely guided sheaths. Ergonomic design with rounded edges for fatigue-free working.

Learn more:



CARAT® Aderer pliers large

Aderer wire bending pliers, three prong with reinforced plier tips, for wires up to 0.9 mm diameter.

/// CARAT® Aderer pliers large

2044.1
1 piece



CARAT® Aderer pliers medium

Aderer wire bending pliers, three prong with reinforced plier tips, for wires up to 0.7 mm diameter.

/// CARAT® Aderer pliers medium

2046.1
1 piece



CARAT® Angle pliers (HM)

Carbide wire bending pliers with a square and a round tip (tungsten carbide), for wires up to 0.7 mm diameter.

/// CARAT® Angle pliers (HM)

2043.1
1 piece



CARAT® Flat pliers

Flat needle-nose pliers according to Marburg model with delicate chequered guiding tips.

/// CARAT® Flat pliers

2041.1
1 piece

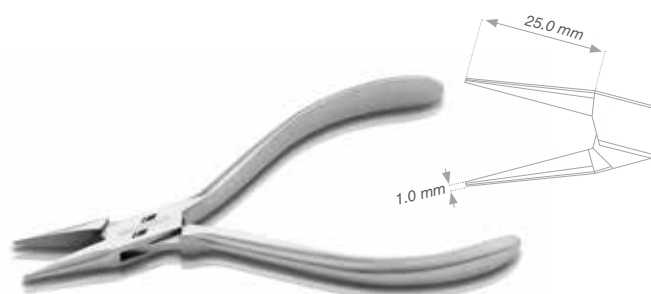

CARAT® Crampon pliers

Pin and wire cutting and bending pliers with chequered and crenate tips, suitable for hard (\varnothing up to 1.2 mm) and soft wires (\varnothing up to 1.5 mm).

/// CARAT® Crampon pliers

2040.1
1 piece



CARAT® Young pliers

Loop and arch bending pliers with multiple crenate tips for labial arches and hard wire (\varnothing bis 0.9 mm).

/// CARAT® Young pliers

2042.1
1 piece

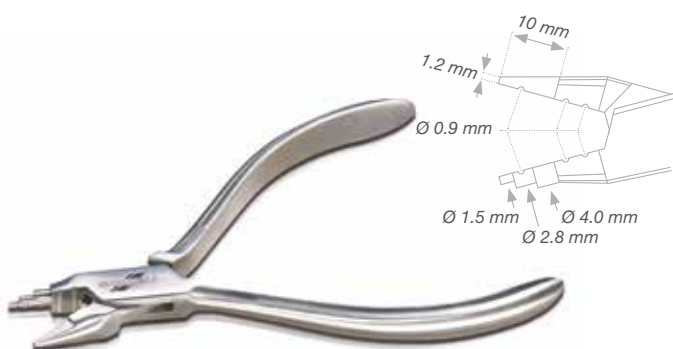

Ortho arch bender

Bending aid from high strength aluminium alloy with 11 different radii for forming round wire (\varnothing 0.5 - 1.5 mm) and square wire (up to 0.8 mm / 031"). High-gloss polished, with laser inscription.

/// Ortho arch bender

8450.1
1 piece



VECTOR® screws

Standard expansion screws, traction screws and special screws with stable construction, skeletal structure and directional arrow, e.g. in miniaturized design, as multi-sectional Bertoni screw or palatal expansion screw. Please refer to the table in the appendix for indications on expansion.

Learn more:



VECTOR® 30

Special miniaturised sector screw with bright yellow directional arrow for single tooth movements. To ensure safe anchorage, retention wires (CHROMIUM Ø 0.8 mm, not included) can be individually inserted and adjusted. Can also be used in the CA® CLEAR ALIGNER technology for oblique-lateral segment expansion acc. to Dr. Pablo Echarrri in conjunction with the CA® Arch CHROMIUM and two VECTOR® 30 screws.

Comes with key for expansion screws.

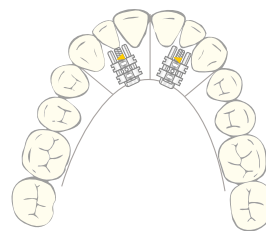
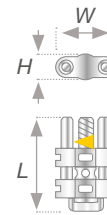
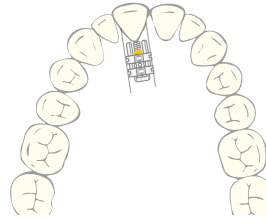

/// special sector screw
4.80 x 2.60 x 9.50 mm
Expansion 3.0 mm

2484.1
2 pieces

2484.2
10 pieces

CE

VECTOR® 40 acc. to Prof. Hinz

Special miniaturised screw with black directional arrow for fabrication of CA® splints, allowing expansions in the lower jaw (up to 3 mm). The retention arms allow safe anchorage using cold curing resin.

/// special screw micro
3.60 x 2.50 x 19.00 mm
Expansion 3.0 mm

2486.1
10 pieces

2486.2
50 pieces

CE

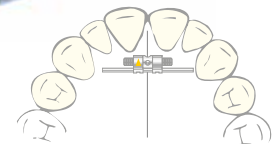
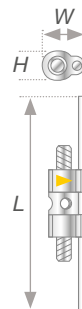

VECTOR® 45 acc. to Prof. Hinz

New

Miniaturised expansion screw with bright yellow directional arrow for fabrication of CA® splints, allowing activation and fan-type expansion (up to 3 mm). Comes with elongated guiding pins for secure anchorage with cold cure resin and torsion-free expansion. In particular for use in the upper jaw.

/// VECTOR® 45 acc. to Prof. Hinz
4.70 x 2.50 x 19.00 mm
Expansion 3.0 mm

2487.1
10 pieces

CE

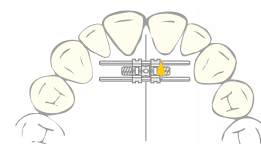
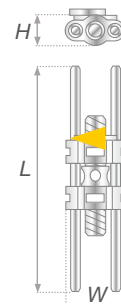

VECTOR® 50

Skeletal miniaturised expansion screw with bright yellow directional arrow for transversal expansion in the lower jaw, also for narrow upper jaws.

/// standard expansion screw micro
4.70 x 2.50 x 10.00 mm
Expansion 3.0 mm

2489.1 **2489.2**
10 pieces 50 pieces

CE

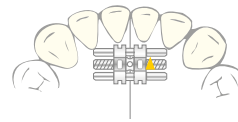
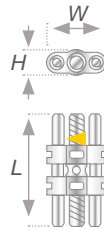

VECTOR® 80

Skeletal expansion screw with bright yellow directional arrow for transversal expansion of the lower jaw. Additional bore hole ensures excellent retention in acrylics.

/// standard expansion screw medium
7.00 x 3.10 x 14.30 mm
Expansion 7.0 mm

2490.1 **2490.2**
10 pieces 50 pieces

CE

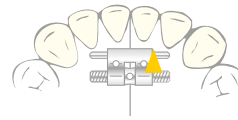
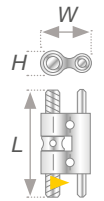

VECTOR® 90 / 100

Skeletal expansion screw with bright yellow directional arrow for transversal expansion of the lower jaw. For treatment of Angle Class II cases we recommend using VECTOR® 100 in combination with VECTOR® 900.

/// VECTOR® 90, standard expansion screw mini
6.20 x 2.80 x 10.00 mm
Expansion 4.0 mm

2491.1 **2491.2**
10 pieces 50 pieces

/// VECTOR® 100, standard expansion screw mini
6.20 x 2.80 x 12.00 mm
Expansion 5.0 mm

2492.1 **2492.2**
10 pieces 50 pieces

CE

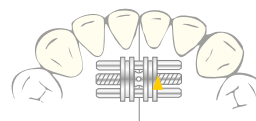
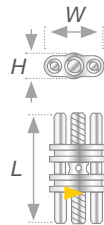

VECTOR® 140 / 160

Skeletal expansion screw with bright yellow directional arrow for transversal and sagittal expansion in the upper and lower jaw.

/// VECTOR® 140, standard expansion screw medium
7.50 x 3.50 x 12.00 mm
Expansion 5.0 mm

2494.1 **2494.2**
10 pieces 50 pieces

/// VECTOR® 160, standard expansion screw medium
7.50 x 3.50 x 14.30 mm
Expansion 6.0 mm

2496.1 **2496.2**
10 pieces 50 pieces

CE

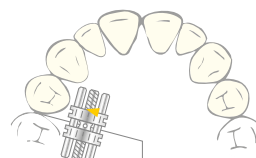
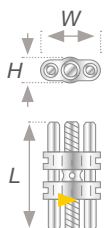

VECTOR® 190 / 200

Stable, skeletal expansion screw with bright yellow directional arrow for transversal expansion of the upper jaw and bimaxillary appliances. Additional bore hole ensures excellent retention in acrylics.

// VECTOR® 190, standard expansion screw medium **2497.1** **2497.2**
 10.00 x 3.10 x 10.00 mm 10 pieces 50 pieces
 Expansion 5.0 mm

// VECTOR® 200, standard expansion screw maxi **2498.1** **2498.2**
 10.00 x 3.10 x 14.30 mm 10 pieces 50 pieces
 Expansion 7.5 mm

CE

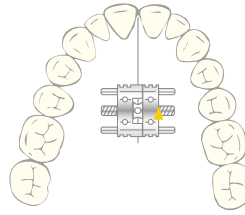
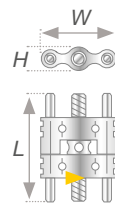

VECTOR® 350

Skeletal miniaturised sector expansion screw with bright yellow directional arrow for single tooth and segment movement in the upper and lower jaw.

// sector expansion screw micro **2509.1** **2509.2**
 4.70 x 2.50 x 10.50 mm 10 pieces 50 pieces
 Expansion 4.0 mm

CE

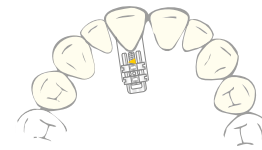
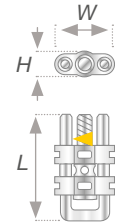

VECTOR® 400

Delicate skeletal sector expansion screw with bright yellow directional arrow. Can also be used for single tooth movements.

// sector expansion screw mini **2510.1** **2510.2**
 6.20 x 2.80 x 11.00 mm 10 pieces 50 pieces
 Expansion 3.0 mm

CE

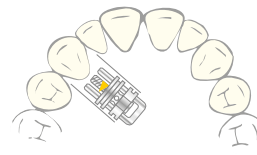
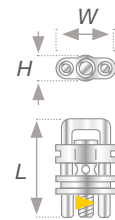

VECTOR® 420

Delicate skeletal sector expansion screw with bright yellow directional arrow. Can be used for distalisation and for single tooth movements.

// sector expansion screw mini **2512.1** **2512.2**
 6.20 x 2.80 x 13.00 mm 10 pieces 50 pieces
 Expansion 5.0 mm

CE

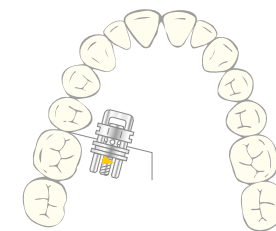
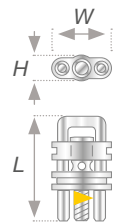

VECTOR® 440

Delicate skeletal sector expansion screw with bright yellow directional arrow, for distalisation.

// sector expansion screw mini **2514.1**
 6.20 x 2.80 x 13.50 mm 10 pieces

CE

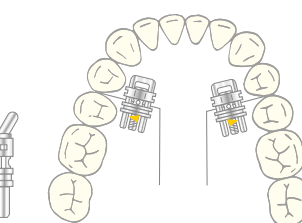
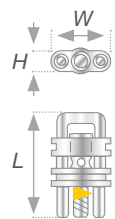

VECTOR® 440R

Delicate skeletal sector expansion screw with bright yellow directional arrow for single tooth or segment movement.

/// sector expansion screw mini
6.20 x 2.80 x 13.50 mm
Expansion 5.0 mm

2513.1
10 pieces

CE

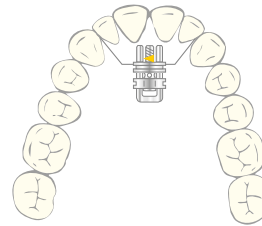
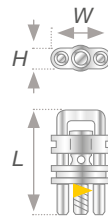

VECTOR® 460

Skeletal sector expansion screw in stronger version with bright yellow directional arrow.

/// sector expansion screw medium
7.50 x 3.50 x 13.00 mm
Expansion 5.0 mm

2516.1
10 pieces

CE

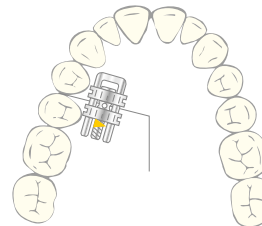
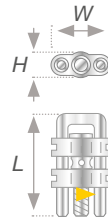

VECTOR® 500 / 520

Traction screw for space closure with black directional arrow on the housing.

/// VECTOR® 500, traction screw
6.20 x 2.80 x 13.50 mm

2520.1
10 pieces

/// VECTOR® 520, traction screw
6.20 x 2.80 x 18.00 mm

2522.1
10 pieces

CE

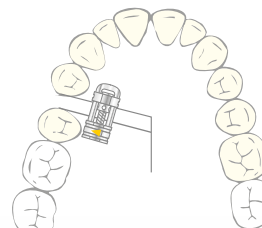
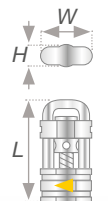

VECTOR® 600 / 620

Special screw for rapid palatal expansion. The anatomically bent retention arms are soldered or welded onto molar bands. The specifically designed housing profile fits perfectly the palatal vault. The integrated polyamide bush prevents accidental resetting of the screw. Laser-welded indication for rotation and expansion on the housing. Comes with security expansion key.

Not suitable for surgically assisted rapid palatal expansion. Protect screw body from excessive heat to avoid damaging the integrated polyamide bushing and jamming of the screw.

/// VECTOR® 600, rapid palatal expansion screw
10.40 x 4.00 x 13.00 mm
Expansion 9.0 mm

2524.1
1 piece

2524.2
10 pieces

/// VECTOR® 620, rapid palatal expansion screw
10.40 x 4.00 x 15.00 mm
Expansion 11.0 mm

2526.1
1 piece

2526.2
10 pieces

CE 0044

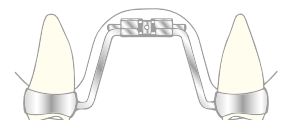
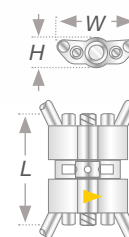
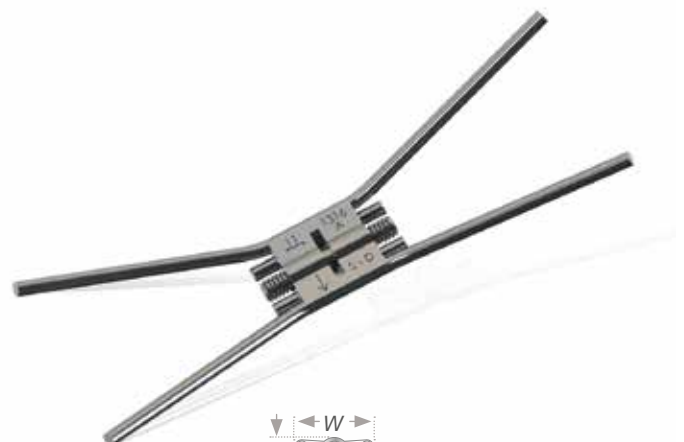

VECTOR® 720 acc. to Bertoni

Special Bertoni screw for insertion in multi-sector plates, enabling separate protrusion and symmetric transversal expansion by two independently operating spindles.

/// VECTOR® 720 acc. to Bertoni
17.00 x 2.80 x 15.50 mm
Expansion 5.5 mm, transversal expansion 7,00 mm

2530.1
2 pieces

CE

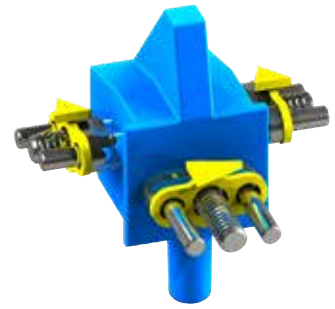
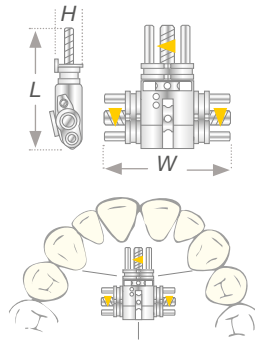

VECTOR® 730 acc. to Bertoni

Special Bertoni screw for insertion in multi-sector plates, enabling separate protrusion and symmetric or asymmetric transversal expansion by three independently operating spindles.

/// VECTOR® 730 acc. to Bertoni
17.00 x 2.80 x 15.50 mm
Expansion 5.5 mm, transversal expansion 2 x 3,50 mm

2532.1
2 pieces

CE

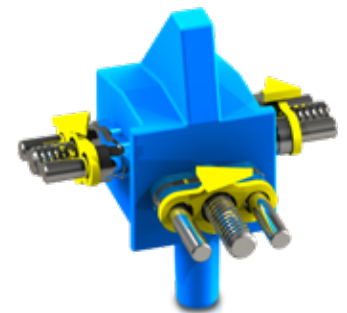
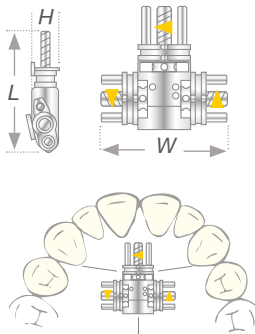

VECTOR® 740 acc. to Bertoni

Modified angled and delicate Bertoni screw for insertion in multi-sector plates, enabling separate protrusion and symmetric transversal expansion by two independently operating spindles.

/// VECTOR® 740 acc. to Bertoni
15.00 x 5.00 x 14.50 mm
Expansion 2.5 mm, transversal expansion 5,00 mm

2540.1
2 pieces

CE

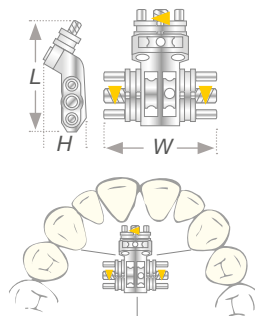

VECTOR® 750 acc. to Bertoni

Modified angled and delicate Bertoni screw for insertion in multi-sector plates, enabling separate protrusion and symmetric or asymmetric transversal expansion by three independently operating spindles, for bilateral expansion.

/// VECTOR® 750 acc. to Bertoni
15.00 x 5.00 x 14.50 mm
Expansion 2.5 mm, transversal expansion 2 x 2,50 mm

2542.1
2 pieces

CE

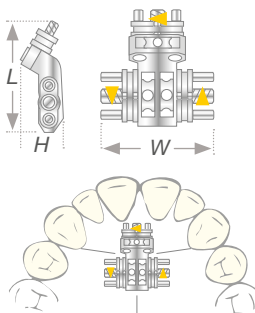

VECTOR® 800 / 820

Special miniaturised screw for distraction of the lower jaw using stable retention arms of 60 mm length. With laser marking on housing.

Not suitable for surgically assisted rapid palatal expansion.

// VECTOR® 800 6.70 x 3.10 x 13.00 mm Expansion 9.0 mm	2533.1 1 piece	2533.2 5 pieces
// VECTOR® 820 6.70 x 3.10 x 15.00 mm Expansion 11.0 mm	2534.1 1 piece	2534.2 5 pieces

CE 0044



VECTOR® 900

Screw for protrusive double plate for treatment of Angle Class II cases (lower jaw retrusion/distal occlusion) as well as for bilateral expansion of the upper jaw in growing children. Compact design with integrated expansion screw, comes with key for expansion. For lower jaw we recommend the combined use with VECTOR® 100 screw.

// VECTOR® 900 14.00 x 20.00 x 13.00 mm expansion 5.0 mm	2537.1 1 piece	2537.2 10 pieces
---	--------------------------	----------------------------

CE

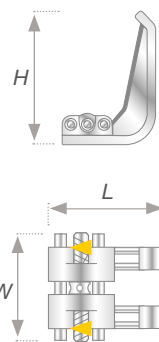

VECTOR® Piston spring screw

Stainless steel screw for single tooth movement during orthodontic treatment with removable appliances. Three different screw lengths allow large protrusion by a constant and precisely controlled amount of pressure on the tooth to be moved.

// 4 mm 1.70 x 1.70 x 5.30 mm	2477.1 5 pieces
// 6 mm 1.70 x 1.70 x 6.50 mm	2478.1 5 pieces
// 8 mm 1.70 x 1.70 x 8.50 mm	2479.1 5 pieces

CE

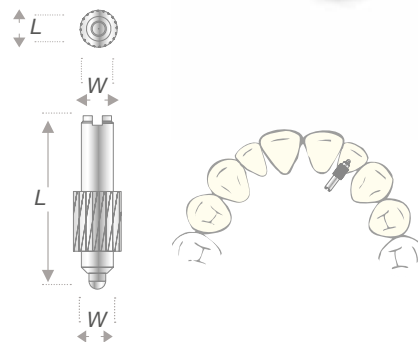

Accessories for VECTOR® screws

Learn more:



Serrated housing nut

For single tooth movement using VECTOR® piston screws during an orthodontic treatment with removable appliances.

// Serrated housing nut

2481.1
5 pieces



Mounting screw

For fixing the serrated housing nut during an orthodontic treatment using VECTOR® piston screws.

Note: Mounting screw is not classified as medical product and not suitable for use in the mouth, contains nickel.

// Mounting screw

2480.1
5 pieces



Reamer

For recutting the thread when fabricating a removable appliance incorporating VECTOR® piston screws.

// Reamer

2482.1
1 piece



Screwdriver F

For activation of VECTOR® piston screws.

The screwdriver is not classified as medical product and not suitable for use in the mouth.

// Screwdriver F

2483.1
1 piece



Key for expansion screws

For precise adjustment of VECTOR® expansion screws.

// Key for expansion screws

2101.2
100 pieces



Security key for expansion screws

For HF5, HF9 and HF15 telescopes (IST® devices) and all kinds of palatal expansion screws.

// Security key for expansion screws

2100.1
10 pieces



Acrylics technique

Learn more:



STEADY-RESIN S

Cold-curing resin for the "salt and pepper" technique. This polymer meets the requirements of the "salt and pepper" technique, such as high stability and optimum wettability.

// polymer

8134.1
1 kg



STEADY-RESIN M

Cold-curing resin for the "premix" technique. Characterised by a wide processing range and excellent modelling properties.

// polymer

8135.1
1 kg



STEADY-RESIN VARIO

Cold-curing resin for orthodontics with prolonged processing time, can be used both for "salt and pepper" and for the modelling techniques.

// polymer

8140.1
1 kg



STEADY-RESIN S+M

Universal monomer, can be processed with all STEADY-RESIN polymer versions. The clear monomer can be mixed with STEADY-RESIN coloured monomers.

// monomer, clear

8136.1
500 ml

// monomer, pink

8137.1
500 ml





STEADY-RESIN Coloured monomer

Ready-to-use coloured STEADY-RESIN monomers for use with STEADY-RESIN S, M and VARIO as well as DURASPLINT® polymer.

// blue	8351.1 100 ml	8351.2 0.25 l
// yellow	8352.1 100 ml	8352.2 0.25 l
// red	8353.1 100 ml	8353.2 0.25 l
// black	8354.1 100 ml	8354.2 0.25 l
// green	8355.1 100 ml	8355.2 0.25 l
// violet	8356.1 100 ml	8356.2 0.25 l

CE



STEADY-RESIN Neon monomer

Ready-to-use coloured neon monomers for use with STEADY-RESIN S, M and VARIO as well as DURASPLINT® polymer. For streak-free and translucent results.

// neon pink	8350.1 100 ml	8350.2 0.25 l
// neon red	8357.1 100 ml	8357.2 0.25 l
// neon yellow	8358.1 100 ml	8358.2 0.25 l
// neon green	8359.1 100 ml	8359.2 0.25 l
// neon blue	8360.1 100 ml	8360.2 0.25 l
// neon orange	8361.1 100 ml	8361.2 0.25 l

CE

STEADY-RESIN polymer

Pre-mixed polymer in two colours. Innovative pigments provide contrasting effects.

// black	8130.1 200 g
// white	8131.1 200 g

CE



Mica

For individual use with STEADY-RESIN and DURASPLINT® polymer. Blends rainbow, rainbow green and rainbow violet are completely metal-free and ensure iridescent effects in delicate pastel shades.

// silver	8144.1 50 g
// gold	8145.1 50 g
// blue	8146.1 50 g
// red	8147.1 50 g
// green	8148.1 50 g
// rainbow	8150.1 50 g
// rainbow green	8151.1 50 g
// rainbow violet	8152.1 50 g

CE



RESIMIX®

Original mixing cups of clear silicone, stable by strong suction base. Very practical pouring spout for medium and large version.

// 5 ml, 3 pieces	7243.1 1 set
// 30 ml, 2 pieces	7284.1 1 set
// 70 ml, 1 piece	7244.1 1 piece



3D Model insulation

Insulation for 3D models when processing cold-curing resin, such as STEADY-RESIN S. Application with enclosed brush provides optimum insulation, suitable for models generated with 3D printers.

// 3D Model insulation

6510.1
65 ml



Orthodontic insulating agent

Alginate insulation for plaster models. Single apply provides optimum insulation.

// Orthodontic insulating agent

8364.1
500 ml



Spray bottle / spray nozzles

Spray bottle with dosing tip and cap is suitable for both monomer and polymer. Perfect dosing by piercing the tip with a needle. Optional spray nozzles available for easier dosing of polymer and monomer can be mounted on the bottle.

// Metal spray nozzles for monomer

8138.1
5 pieces

// Metal spray nozzles for polymer

8139.1
5 pieces

// Spray bottle, 100 ml

8141.1
1 piece



Set-up technique

Learn more:



Set-up plaster

White formaldehyde-free plaster offers best conditions for use in general orthodontics and the CA® CLEAR ALIGNER technology.

Technical data according to DIN EN ISO 6873

Compressive strength after 24 hours 65 MPa

Expansion after 2 hours < 0.09

// Set-up plaster	5266.1 2.5 kg	5266.2 5 kg
-------------------	------------------	----------------



Set-up manual saw

The angled bar allows precise and controlled separation of the individual tooth segments.

Saw blades available in two sizes.

// Set-up manual saw	5372.1 1 piece
// Saw blades W x H x L: 0.15 x 2.0 x 75.0 mm	5373.1 10 pieces
// Saw blades W x H x L: 0.20 x 2.0 x 75.0 mm	5379.1 10 pieces



BLUE-BLOKKER®

Light-curing, blue-transparent blocking-out and modelling putty with optimum flow properties. For fabrication of space holders for bleaching splints and medical trays as well as for sealing and blocking set-up models. Burns without leaving any residue, can therefore also be used in prosthetics for the fabrication of fixed and removable prostheses. Telescopic models are stable and can be withdrawn without tension. Curing in the wavelength range of 380 - 470 nm.

// 4 x 1.5 g incl. 2 cannula Ø 0.6 mm and 8 cannula Ø 0.9 mm	5276.1 1 piece
---	-------------------



Set-up wax blocks

Fast-melting wax for transpositions in orthodontics.

// red

5368.1
1 set



Set-up wax rods

Soft set-up wax with good adhesion properties.

// opaque

5268.1
25 pieces



Diamond separating disc

Diamond coated on both sides (thickness 0.28 mm) for very precise saw cuts on set-up models and for finishing splints.

// Diamond separating disc
mounted on mandrel, Ø 22 mm
maximum rotational speed: 5,000 r/min

5288.1
1 piece



Set-up trimmer

Special carbide bur for drilling and vertical cuts.

// Set-up trimmer
25,000 r/min

5371.1
1 piece



Hinges and face bows

Learn more:



Hinge system acc. to Herbst

For treatment of class II cases, for soldering or welding on cast or ready-made bands. Without limit stop.

// without fastening elements 1 pair of hinges	5478.1 1 pair
// with hexagon socket screws Set: 1 pair of hinges and 4 pairs of fastening elements incl. hexagon socket screws	5479.1 1 pair
// with slotted screws Set: 1 pair of hinges and 4 pairs of fastening elements incl. slotted screws	5480.1 1 pair

CE 0044

Herbst is a registered trade mark of DENTAURUM GmbH & Co. KG, Ispringen.



Fastening elements for Herbst appliance

Come with slotted or hexagon socket screws, to be welded or soldered on to cast or ready-made bands.

// with hexagon socket screws 4 pairs of fastening elements incl. hexagon socket screws	5455.1 4 pairs
// with slotted screws 4 pairs of fastening elements incl. slotted screws	5456.1 4 pairs

CE 0044

Herbst is a registered trade mark of DENTAURUM GmbH & Co. KG, Ispringen.



Distance rings

When fabricating Herbst appliances, distance rings can be slid onto connecting rods, enabling progressive re-activation. Inner diameter: 2.0 mm.

// length 1 mm	5481.1 10 pieces
// length 2 mm	5482.1 10 pieces
// length 3 mm	5483.1 10 pieces
// length 4 mm	5484.1 10 pieces
// length 5 mm	5485.1 10 pieces

CE 0044

Herbst is a registered trade mark of DENTAURUM GmbH & Co. KG, Ispringen.



Hinge 44 with slotted screw

For treatment of class II cases with removable or cemented splints. Laser-welded retention (44 mm) ensures secure anchorage in the splints, without stop.

// Hinge 44 kit 1 pair of hinges and 4 pairs of fastening elements	5490.1 1 kit
// Fastening elements with retention, for hinge system, 44 mm 4 pairs of fastening elements	5489.1 4 pairs

CE 0044



Activator tubes

For insertion of face bows in individually curved Adams clasps, double-sided stable laser welding.

// 1.15/4.5 mm with wire 0.7 mm sh Inner diameter 1.15 mm/.045", length 4.5 mm Wire: 0.7 mm spring hard, length 125 mm	2470.1 10 pieces
// 1.15/6 mm with wire 0.8 mm sh Inner diameter 1.15 mm/.045", length 6.0 mm Wire: 0.8 mm spring hard, length 125 mm	2471.1 10 pieces
// 1.15/6 mm with wire 1.0 mm h Inner diameter 1.15 mm/.045", length 6.0 mm Wire: 1.0 mm hard, length 125 mm	2472.1 10 pieces

CE



Activator tubes acc. to Teuscher

Polymerisable fixation for face-bows.

// Ø 1.30 mm / .051" Inner diameter: 1.30 mm / .051"	2434.1 10 pieces
// Ø 1.15 mm / .045" Inner diameter: 1.15 mm / .045"	2436.1 10 pieces

CE



ORTHOFIT® Anatomic

Face bow made of high-gloss polished stainless steel. Inner and outer bow (Ø 1.8 mm) double-sided laser welded. Permanent centre marking and coloured caps to identify the size. Inner bow made of one piece, with a rod length of 120 mm. Available with two outer bows of different lengths.

// short (red)

2450.1
1 piece

// regular (blue)

2451.1
1 piece

CE

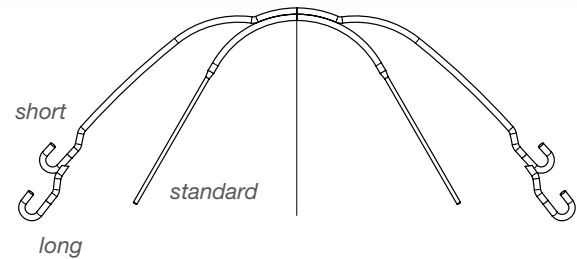

Face bow polished

Face bow made of high-gloss polished stainless steel. Inner and outer bow (Ø 2.0 mm) double-sided laser welded. Permanent centre marking and coloured caps to identify the size. Inner bow made of one piece, with a rod length of 120 mm. Available with regular or short outer bow with bent outer loops as well as standard inner bow. Wire ends of outer loops are laser deburred.

// standard, regular, white

2119.1
1 piece

// standard, short (white)

2439.1
1 piece

CE

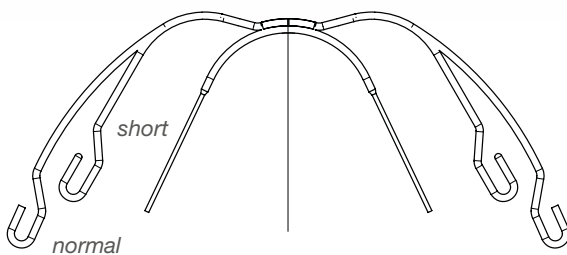

Accessories

Learn more:



Silicone tube

For covering clasp wires.

// Ø 1.0 internal / 2.0 mm external

3211.1
1 m



Angle tester acc. to Adamik

For fixing and controlling the insertion angle of guiding bars and screws for protrusive double plates.

// Angle tester acc. to Adamik

2332.1
1 piece



Symmetry measurement gauge

6 mm acrylic glass plate with mounting pins for exact positioning on the raphe palati. 2 mm grid allows precise determination of sagittal and transversal asymmetries of dental arch length and width.

// Symmetry measurement gauge

8431.1
1 piece



Positioning aid

For insertion and alignment of guiding bars and expansion screws.

// Positioning support

2331.1
5 pieces



CETRON® Cleaning powder

Mild powder for long lasting care and cleaning of orthodontic plates, splints, dentures and sports mouth guards. To dissolve in 150 ml of water.



// German	3237.1 5 bags	3237.2 25 bags	3237.3 250 bags
// English	3239.1 5 bags	3239.2 25 bags	3239.3 250 bags



CETRON® Care spray

Care and cleaning of splints, dentures, orthodontic plates, mouth guard and snoring appliances. Fresh lemon taste reduces typical monomer taste, ensuring highly polished appliances and high wearing comfort at the same time.

// CETRON® Care spray	3238.1 75 ml
-----------------------	-----------------

CE



CETRON® Care set

Hygienic and long lasting care and cleaning of splints, dentures, orthodontic plates, mouth guard and snoring appliances.

<p>// CETRON® Care set incl. cleaning box, brush and 5 bags CETRON® cleaning powder of 15 g</p>	<p>3236.1 1 set</p>
--	--------------------------------



Retainer boxes

For orthodontic appliances or BIOPLAST® sports mouth guards. Available in blue, yellow, green, red and violet.

<p>// Retainer boxes 10 pieces (5 colours, 2 each)</p>	<p>5435.1 10 pieces</p>
---	------------------------------------



CA[®] CLEAR ALIGNER



The right concept for every demand.

Many things are different with CA[®] CLEAR ALIGNER: the shape of the splint, the material thickness... But the most essential difference: It's up to you to decide – holding the complete value creation in your hands or calling for the services of CA DIGITAL. CA[®] CLEAR ALIGNER leaves you all the options.

More than 400,000 patients have been successfully treated with CA[®] CLEAR ALIGNER – a significant number and above all a wide diversity of experience. For more information visit www.ca-clear-aligner.com.

CA [®] Software and accessories.....	54	Interproximal enamel reduction	61
CA [®] Foils.....	56	CA [®] POWER GRIP	63
Screws and wires.....	57	Accessories	65
CA [®] TIP Pliers.....	59	Technical literature.....	67

One system – many options.

The complete value creation in your hands. The individual components of the CA® CLEAR ALIGNER system give you the opportunity to carry out the treatment from diagnosis to therapy planning, fabrication of set-up models until the final splint fabrication and activation in your laboratory or practice. The necessary equipment consists of the pressure moulding devices MINISTAR S® or BIOSTAR®, the CA® foils in soft, medium and hard, the software CA® SMART 2D including web cam, CA® photo support and CA® CHECKER.

Interested in getting started with digital splint therapy? Orthodontists and dentists will find an ideal partner with CA DIGITAL, a service provider offering the complete range of digital treatment solutions. Whether you prefer receiving printed models of digitally planned set-ups in order to carry out the fabrication of the splints yourself or if you want to order digital planning including splint fabrication: CA DIGITAL is your individual partner for all your requirements.

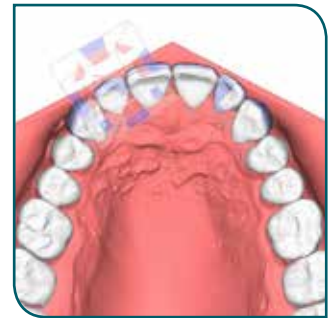

The 3-Splint-System

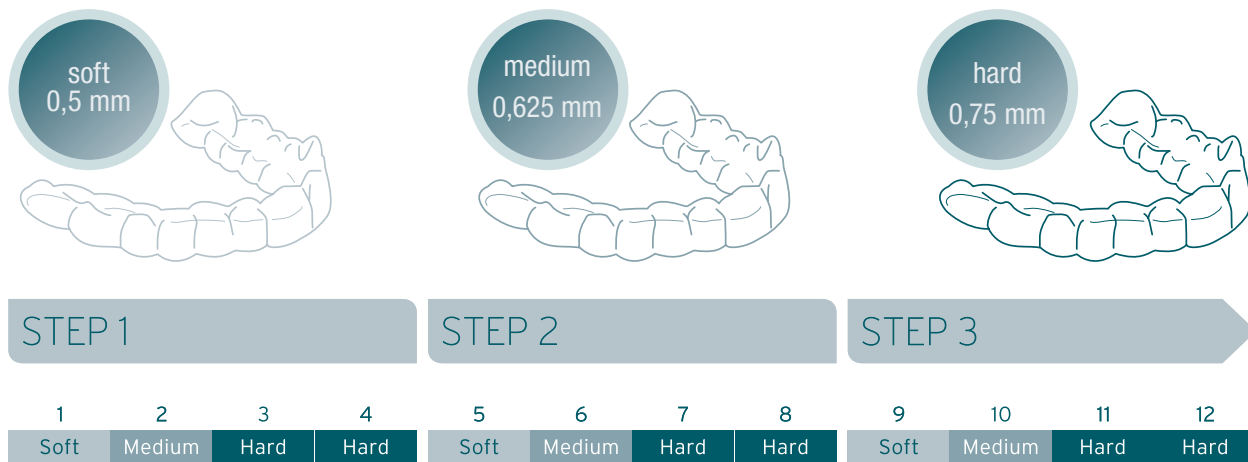

Three material thicknesses worn during four weeks for a unique and beautiful smile: during each treatment step, the patient wears three splints of various thicknesses. Thanks to the steady increase in pressure, teeth are efficiently, yet smoothly aligned – with extraordinary comfort. The special design with additional covering of the gingival margin (2-3 mm) increases power transmission and ensures even more efficiency in treatment.

CA[®] CLEAR ALIGNER: a global success story.

The CA[®] CLEAR ALIGNER therapy system is mentored by an international board of experienced specialists from science and technology, contributing their expertise in orthodontics, dental technology and material

science. This expert panel chaired by Dr. Pablo Echarri is in constant contact to share new findings in seminars, workshops and technical articles with CA[®] users.

- more than 3,000 certified orthodontists
- more than 300 certified laboratories
- more than 20 years of clinical experience
- more than 400,000 CA[®] treatment cases

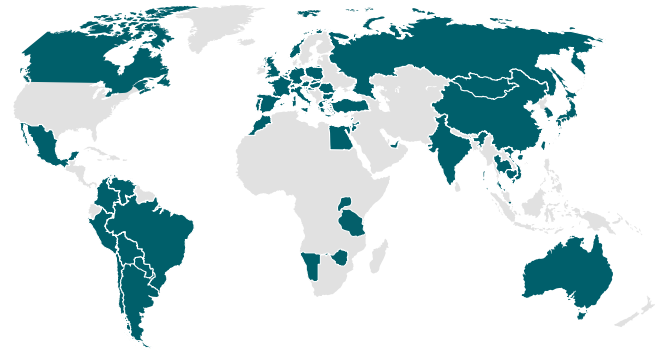

Extensive support in every respect.

Professional

Actual case studies of our international specialists are regularly published as CA[®] Clinical Paper at www.ca-clear-aligner.com/en/b2b/indikationen. New findings in treatment planning are recorded in clinical protocols and shared with our certified CA[®] partners.

Personal

Our CA[®] partners are consistently encouraged by Direct phone or personal support as well as by Practical training in our SCHEU-ACADEMY.

Communicative

We provide free images and videoclips for your website as well as patient information for your practice.



CA® Software and accessories

Learn more:



CA® SMART 2D version 4.0

The CA® SMART 2D in the upgraded version 4.0 is the perfect entry to the CA® technique, enabling new ways in transposition. Thanks to the modified presentation of the different views it is possible to take lateral and vestibular photos in addition to frontal and occlusal photos. Single or multi-user installation, can be carried out by your local system administrator. Comes with CA® web cam.

System requirements

From Windows 7 Service Pack 1, USB 2.0 port, OpenGL Version ≥ 2.1 and DirectX 9.0c, monitor with resolution of min. 1024 px \times 768 px, mouse with scroll wheel

// CA® SMART 2D version 4.0

5311.1
1 piece



CA® CHECKER

Set consisting of digital precision measuring device with USB port, solid base plate made of polished granite, model holder, spherical bur and level. Precision measurement device equipped with capacitive inclination sensors for determination of torque and angulation values before and after transpositions on set-up models.

System requirements

From Windows 7 Service Pack 1, USB 2.0 port, OpenGL Version ≥ 2.0 and DirectX 9.0c, monitor with resolution of min. 1024 px \times 768 px

// CA® CHECKER

5274.1
1 piece



CA® Photo support 4.0

The stable height adjustable support for the CA® web cam enables reproducible documentation of occlusal and frontal photos. Technical precondition and separate accessory for the CA® SMART 2D software. CA® photo support comes with calibration plate. CA® web cam is not part of the CA® photo support, but part of the CA® SMART 2D software.

Dimensions (W x H x D): 180 x 210 x 195 mm

// CA® Photo support 4.0

5315.1
1 piece



Extension set (4.0) for CA® photo support

The extension set for the CA® SMART 2D 4.0 software allows taking lateral and vestibular photos in addition to occlusal and frontal ones.

- // Extension set (4.0) for CA® photo support **5313.1**
 Contents: 1 CA® model holder, 1 hexagon key, 2 height adjustment blocks, 1 CA® SMART Matrix, pins, sleeves, labels for identifying height adjustment blocks 1 piece



Fixing block for height adjustment of CA® photo support

For fixing the exact height of a model, used with the CA® photo support, removable; remains at the model during processing, enables parallel work on several patient cases.

- // Fixing block for height adjustment of CA® photo support **5314.1**
 Height adjustment block incl. labels for identifying height adjustment blocks 1 piece



CA® Model holder for photo support 4.0

For photo support with CA SMART 2D software 4.0, enables occlusal frontal and lateral photos.

- // CA® Model holder for photo support 4.0 **5361.1**
1 piece



CA® Foils

Learn more:



CA® Foil

High-quality, transparent, hard-elastic material for gentle tooth alignment with aesthetic splints in the CA® system. Material with original CA® labelling stating the thickness: extra soft (0.4 mm), soft (0.5 mm), medium (0.625 mm) and hard (0.75 mm).

// extra soft, 0.4 x 125 mm	3441.1 10 pieces	
// soft, 0.5 x 125 mm	3405.1 10 pieces	3405.2 100 pieces
// medium, 0.625 x 125 mm	3406.1 10 pieces	3406.2 100 pieces
// hard, 0.75 x 125 mm	3407.1 10 pieces	3407.2 100 pieces

Delivery exclusively to certified CA® CLEAR ALIGNER partners.



CA® Retention foil pd

CA® Retention foils for long-term use, pre-dried and individually vacuum sealed. Material with original CA® labelling stating the thickness (0.75 and 1.0 mm).

// 0.75 x 125 mm	3438.1 10 pieces
// 1.0 x 125 mm	3440.1 10 pieces

Delivery exclusively to certified CA® CLEAR ALIGNER partners.



Screws and wires

Learn more:



CA® Arch CHROMIUM

Pre-bent arch made of CHROMIUM wire as auxiliary element. Tapered ends facilitate sliding-on the screws. Wire diameter: 0.8 mm

Application

For the fabrication of special CA® CLEAR ALIGNER splints with two built-in VECTOR® 30 sector screws for lateral-oblique segment expansion acc. to Dr. Pablo Echarri.



CA® Arch CHROMIUM

5317.1
5 pieces



VECTOR® 30

Special miniaturised sector screw with bright yellow directional arrow for single tooth movements. To ensure safe anchorage, retention wires (CHROMIUM Ø 0.8 mm, not included) can be individually inserted and adjusted. Can also be used in the CA® CLEAR ALIGNER technology for oblique-lateral segment expansion acc. to Dr. Pablo Echarri in conjunction with the CA® Arch CHROMIUM and two VECTOR® 30 screws.

Comes with key for expansion screws.

special sector screw
4.80 x 2.60 x 9.50 mm
Expansion 3.0 mm

2484.1
2 pieces

2484.2
10 pieces

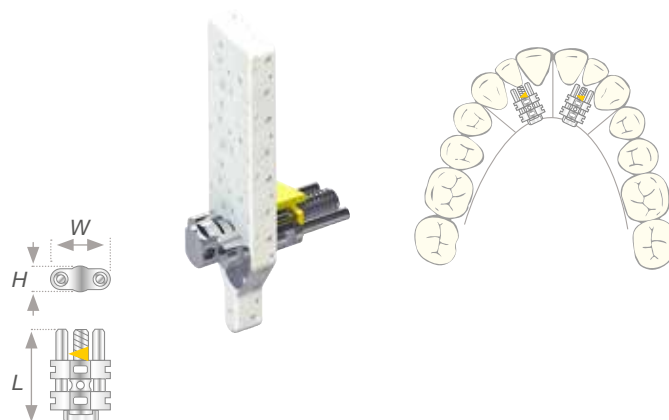

VECTOR® 40 acc. to Prof. Hinz

Special miniaturised screw with black directional arrow for fabrication of CA® splints, allowing expansions in the lower jaw (up to 3 mm). The retention arms allow safe anchorage using cold curing resin.

special screw micro
3.60 x 2.50 x 19.00 mm
Expansion 3.0 mm

2486.1
10 pieces

2486.2
50 pieces



New

VECTOR® 45 acc. to Prof. Hinz

Miniaturised expansion screw with bright yellow directional arrow for fabrication of CA® splints, allowing activation and fan-type expansion (up to 3 mm). Comes with elongated guiding pins for secure anchorage with cold cure resin and torsion-free expansion. In particular for use in the upper jaw.

// VECTOR® 45 acc. to Prof. Hinz
4.70 x 2.50 x 19.00 mm
Expansion 3.0 mm

2487.1
10 pieces

CE

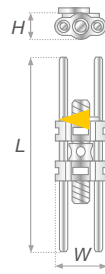

CA® Distalizer kit acc. to Dr. Echarri

Kit for the fabrication of a CA® Distalizer acc. to Dr. Echarri for one and double-sided distalisation of molars.

All components available separately, for article numbers please refer to instruction.

// CA® Distalizer kit acc. to Dr. Echarri
1 CA® pressure spring, 1 CA® guiding rod, 1 CA® telescope sleeve with silicone tube, 1 VECTOR® 350 with key for expansion screws

5319.1
1 kit

CE



TFA-Kit acc. to Dr. Echarri

Kit for the fabrication of a TFA splint (Tractive Force Appliance) acc. to Dr. Echarri for space closure of posterior teeth.

All components available separately, for article numbers please refer to instruction.

// TFA-Kit acc. to Dr. Echarri
traction 3.0 mm

5329.1
1 kit

CE



CA[®] TIP Pliers

Learn more:



CA[®] TIP 1

Large spherical tip allows insertion of retention points in CA[®] splints, for increase of friction. Stainless steel, sterilisable.

Warranty: 5 years.

CA[®] TIP 1
hemisphere: Ø 1.45 mm

5281.1
1 piece

CE



CA[®] TIP 2

Small spherical tip allows forming of activation points in CA[®] splints. Stainless steel, sterilisable.

Warranty: 5 years.

CA[®] TIP 2
hemisphere: Ø 1.0 mm

5291.1
1 piece

CE



CA[®] TIP 3

Pliers with oval plateau, enable creation of activation surfaces in CA[®] splints. Stainless steel, sterilisable.

Warranty: 5 years.

CA[®] TIP 3
oval plateau: 3.6 x 1.5 mm

5292.1
1 piece

CE



CA® TIP 4

Pliers for torque control with curved plateau, enable creation of labial /lingual activation surfaces in CA® splints. Stainless steel, sterilisable.

Warranty: 5 years.

// CA® TIP 4
curved plateau: 4.0 x 2.5 mm

5295.1
1 piece

CE



New

CA® TIP 5

Pliers for aligners with angled pliers head for correction of splint edges in case of gingival pressure marks. Stainless steel, sterilizable.

Warranty: 5 years.

// CA® TIP 5

5299.1
1 piece

CE



New

CA® TIP 6

Pliers for aligners for removal of activation points and surfaces inserted by means of CA® TIP 2, 3 and 4. Also suitable for finishing and smoothing of the splint surface. Stainless steel, sterilizable.

Warranty: 5 years.

// CA® TIP 6

5323.1
1 piece

CE



Interproximal enamel reduction

CA® Strip Opener

Instruments for opening an interdental gap in case of extreme crowdings, sterilizable, diamond coated on both sides, very thin and with serrated incisal edge. For use before carrying out an interproximal enamel reduction (IER), available with diamond particle size of 15 µm or 40 µm.

CA® Strip Opener should always be used with an oscillating EVA hand piece.

<p>// 15 µm, double-sided diamond coating orange, blade thickness approx. 0.09 - 0.15 mm</p>	<p>5326.1 1 piece</p>
<p>// 40 µm, double-sided diamond coating red, blade thickness approx. 0.175 - 0.235 mm</p>	<p>5327.1 1 piece</p>

CE



CA® Stripping Tool

Instruments for interproximal enamel reduction (IER), diamond coated on one or both sides, available in 12 versions. Coating on left, right or both sides. Additional CA® Stripping Tool (15 µm) with extremely fine and smooth diamond coating on both sides available for polishing. CA® Stripping Tools with 90µm diamond particle size (green) are not to be used for enamel removal, only for reduction of fillings and crowns.

Use CA® Stripping Tools either with an EVA hand piece or a sterilisable stainless steel holder.



<p>// 90 µm, diamond coating left</p>	<p>5342.1 1 piece</p>
<p>// 90 µm, diamond coating right</p>	<p>5343.1 1 piece</p>
<p>// 90 µm, double-sided diamond coating</p>	<p>5344.1 1 piece</p>
<p>// 60 µm, diamond coating left</p>	<p>5345.1 1 piece</p>
<p>// 60 µm, diamond coating right</p>	<p>5346.1 1 piece</p>
<p>// 60 µm, double-sided diamond coating</p>	<p>5347.1 1 piece</p>
<p>// 40 µm, diamond coating left</p>	<p>5348.1 1 piece</p>
<p>// 40 µm, diamond coating right</p>	<p>5349.1 1 piece</p>
<p>// 40 µm, double-sided diamond coating</p>	<p>5350.1 1 piece</p>
<p>// 25 µm, diamond coating left</p>	<p>5351.1 1 piece</p>
<p>// 25 µm, diamond coating right</p>	<p>5352.1 1 piece</p>
<p>// 25 µm, double-sided diamond coating</p>	<p>5353.1 1 piece</p>
<p>// 15 µm, double-sided diamond coating</p>	<p>5354.1 1 piece</p>

CE

Stainless steel holder

With straight and angled attachment for secure handling of CA® Stripping Tools without EVA hand piece, sterilizable.

Can also be used for all other instruments with shaft diameter of 2.35 mm.

Stainless steel holder

5358.1
1 piece



ECHARRI PST Set

Set acc. to Dr. Pablo Echarri for use in the progressive stripping therapy (PST) containing CA® Stripping Tools with double-sided diamond coating in five diamond particle sizes. Ensures a very smooth enamel finish using an EVA handle. Autoclavable.

CA® Stripping Tools with 90µm diamond particle size (green) are not to be used for enamel removal, only for reduction of fillings and crowns.

ECHARRI PST Set

comes in aluminium case containing 1 x CA® Stripping Tool in 90 µm (green), 60 µm (grey), 40 µm (red), 25 µm (white) and 15 µm (yellow), double-sided diamond coating and CA® Gauge

5341.1
1 set

CE



CA® Gauge

Set of stainless steel for control of enamel reduction. Autoclavable up to max. 135° Celsius.

0.1 - 0.5 mm

5316.1
1 piece

CE



CA® POWER GRIP

CA® POWER GRIP set

CA® POWER GRIP silicone forms enable the fabrication of individual attachments for the CA® CLEAR ALIGNER technology. The set contains nine different moulds that can be filled with light-curing composite for direct application on the prepared tooth as well as two appropriate stainless steel holders for positioning CA® POWER GRIP moulds.



CA® POWER GRIP MFM

MFM (multifunctional forced movement): is used for extrusion and mesial/distal rotation. For use with CA® splints and elastics.



CA® POWER GRIP MDI

MDI (mesial/distal inclination): enables setting upright frontal teeth and for mesial/distal inclination.



CA® POWER GRIP DMI

DMI (distal mesial inclination): enables setting upright frontal teeth and for distal/mesial tooth inclinations.



CA® POWER GRIP FALA

FALA (force application LABIAL): used for protrusion, retrusion and torque control up to 3°. For creation of activation surfaces on the teeth in the gingival area with labial placement – for teeth: 11, 13, 21, 23, 33 and 43.



CA® POWER GRIP FALI

FALI (force application LINGUAL): used for protrusion, retrusion and torque control up to 3°. For creation of activation surfaces on the teeth in the gingival area with labial, lingual and palatal placement – for teeth: 12, 22, 31, 32, 41 and 42.



Learn more:





CA® POWER GRIP BUB

BUB (Build-Up bicuspid): round pad for molars (3 mm) used for occlusal bite elevation (approx. 2 mm).



CA® POWER GRIP BUAS

BUAS (Build-Up anterior small, width 2 mm): used as intrusion plateau for the treatment of deep bite. Helps maintaining intrusion forces while the patient is not wearing the CA® CLEAR ALIGNER, allows molar extrusion.



CA® POWER GRIP BUAL

BUAL (Build-Up anterior large, width 4 mm) also serves as intrusion plateau for the treatment of deep bite, width adjusted to front teeth with larger palatal surface.



CA® POWER GRIP BUM

BUM (Build-Up molar): oval molar pad (3 × 5 mm) used for occlusal bite elevation (approx 2 mm).



CA® POWER GRIP holder

For positioning CA® POWER GRIP silicone moulds. Stainless steel, sterilisable.

/// CA® POWER GRIP set
incl. 2 holders and 18 silicone moulds (9 versions, 2 pieces each),
instructions and CD **5338.1**
1 kit

/// CA® POWER GRIP MFM **5330.1**
2 pieces

/// CA® POWER GRIP MDI **5331.1**
2 pieces

/// CA® POWER GRIP DMI **5332.1**
2 pieces

/// CA® POWER GRIP FALA **5333.1**
2 pieces

/// CA® POWER GRIP FALI **5334.1**
2 pieces

/// CA® POWER GRIP BUB **5335.1**
2 pieces

/// CA® POWER GRIP BUM **5336.1**
2 pieces

/// CA® POWER GRIP BUAS **5337.1**
2 pieces

/// CA® POWER GRIP BUAL **5339.1**
2 pieces

/// CA® POWER GRIP holder
one holder each for frontal and posterior region, stainless steel,
sterilisable **5340.1**
2 pieces

Accessories

Learn more:



CA® Splint bags

Resealable minigrip splint bags for passing on the CA® splints to the patient, can be labelled individually.

// CA® Splint bags

5283.1
100 pieces

Delivery exclusively to certified CA® CLEAR ALIGNER partners.



CA® Splint case for patients

Handy zipped case for storing and carrying CA® splints. Resealable CA® splint bags for passing on the CA® splints to the patient, can be labelled individually. Splint remover for easy removal of pressure moulded splints.

// CA® Splint case for patients
comes with CA® Travel Case, 3 CETRON® cleansing powder bags
of 15 g, 3 CA® splint bags, splint remover

5282.1
1 piece

Delivery exclusively to certified CA® CLEAR ALIGNER partners.



CA® Travel Case

Retainer box for up to two CA® CLEAR ALIGNER splints. Specific shape to fit easily into purse or luggage. Detachable lid with additional space for expansion key, two ventilation holes.

// CA® Travel Case

5303.1
1 piece

Delivery exclusively to certified CA® CLEAR ALIGNER partners.



CA® FLASH

For insulation and easy removal when fabricating pressure moulded CA® splints. CA® FLASH is applied to ISOFLAN® foil prior to pressure moulding.

// CA® FLASH
100 ml pump spray bottle, without propellant gas

5308.1
100 ml



CA® Grinding set

Grinding set for finishing CA® CLEAR ALIGNER splints, comes with six different instruments and dressing stone.

CA® Grinding set	5263.1
Comes with set-up and diamond separating disc, DIMO® PRO with mandrel, HM-tricutter (fine), set-up trimmer, dressing stone and CA® carbide bur.	1 piece



CA® Plastic buttons

Transparent plastic buttons allow placing elastics in the treatment of class II and III.

CA® Plastic buttons	5301.1	5301.2
	4 pieces	40 pieces

CE



CA® Cyano Veneer Fast / CA® Pipettes

Crystal-clear, fast-curing bonding agent for adhesion of CA® plastic buttons on CA® splints, can also be used for secure adhesion of screws for Herbst and IST® appliances. CA® pipettes for precise dosing of adhesive.

CA® Cyano Veneer Fast	5302.1
	5 g
CA® Pipettes	5300.1
	25 pieces

CE



CA® Coloured pencils

Coloured pencils for marking the CA® measuring points on the hard plaster models, with red and blue lead.

CA® Coloured pencils	5290.1
	2 pieces



Splint Remover

Using the splint remover, the patient can easily remove aligners or pressure moulded splints.

// Splint Remover

5359.1
5 pieces



ECHARRI Template kit

Comes with ECHARRI Ceph template, ECHARRI Arch template and ECHARRI VTO templates as well as detailed instructions.

// ECHARRI Template kit

8435.1
1 piece



Technical literature

CA® Book, volume 1

CA® Book by Dr. Pablo Echarri on CA® splint therapy with detailed description of the CA® CLEAR ALIGNER treatment concept including diagnosis, indication and fabrication. More than 430 pages with many coloured illustrations.

// German

5298.1
1 piece

// English

5305.1
1 piece



Learn more:



CA® Book Advanced, volume 2

Complements volume 1, for advanced users. With advanced therapeutic options of the CA® CLEAR ALIGNER system and survey of the state-of-the-art in CA® CLEAR ALIGNER technology, such as Progressive Stripping Therapy (PST), CA® POWER GRIP moulds No.1-9, VECTOR® 30, CA® Distalizer Kit acc. to Dr. Echarri, digital technology, extraction cases and combined therapy. More than 250 pages with many coloured illustrations.

// German

5307.1
1 piece

// English

5309.1
1 piece





CAD / CAM

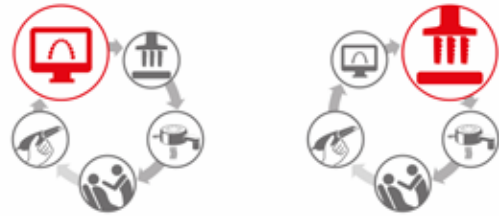

Having the future in sight.

Universal, validated, reliable: Together with our joint venture pro3dure medical GmbH and Australian 3D printing specialist ASIGA Pty. Ltd., we have managed to develop the IMPRIMO® system into a complete solution offering you a validated process flow including 3D printing, cleaning and light curing. Whether for beginners, for advanced users or professionals – the IMPRIMO® system with its

tailored range of devices, consumables and accessories meets any demand in medical 3D printing. It goes without saying that we support you individually with the set-up and the use of the devices as well as the peripheral equipment. Please contact us; we will be glad to assist you.

3D Printing	70	3D Software	80
IMPRIMO® LC resins for 3D printing	76	Milling technology	81

3D Printing

Learn more:



Asiga MAX™

With DLP technology and maximum ease of use, the Asiga MAX™ printer allows for fast, precise and efficient operation. The built-in LCD panel with touch function displays the information on the current construction process and allows interactive control of the printer. The light sensor provides consistent projector performance and uniform resin curing, the smart positioning system (SPS™) ensures precise printing results. Print jobs can be stored in a queue, started from the control panel and transmitted via Ethernet or WiFi. The printer can also operate as a wireless hot spot.

Technical data

Dimensions (W x D x H): 260 x 380 x 370 mm
Build volume (X, Y, Z): 119 x 67 x 75 mm
Consistent data formats: STL, SLC, STM
Image technology: DLP
Pixel size: 62 µm
Light source: UV LED projector with HD chip
Wavelength: 385 nm
Voltage source: 100 - 240 V, 50/60 Hz
Power: 500 W

// Asiga MAX™

6501.1
1 piece

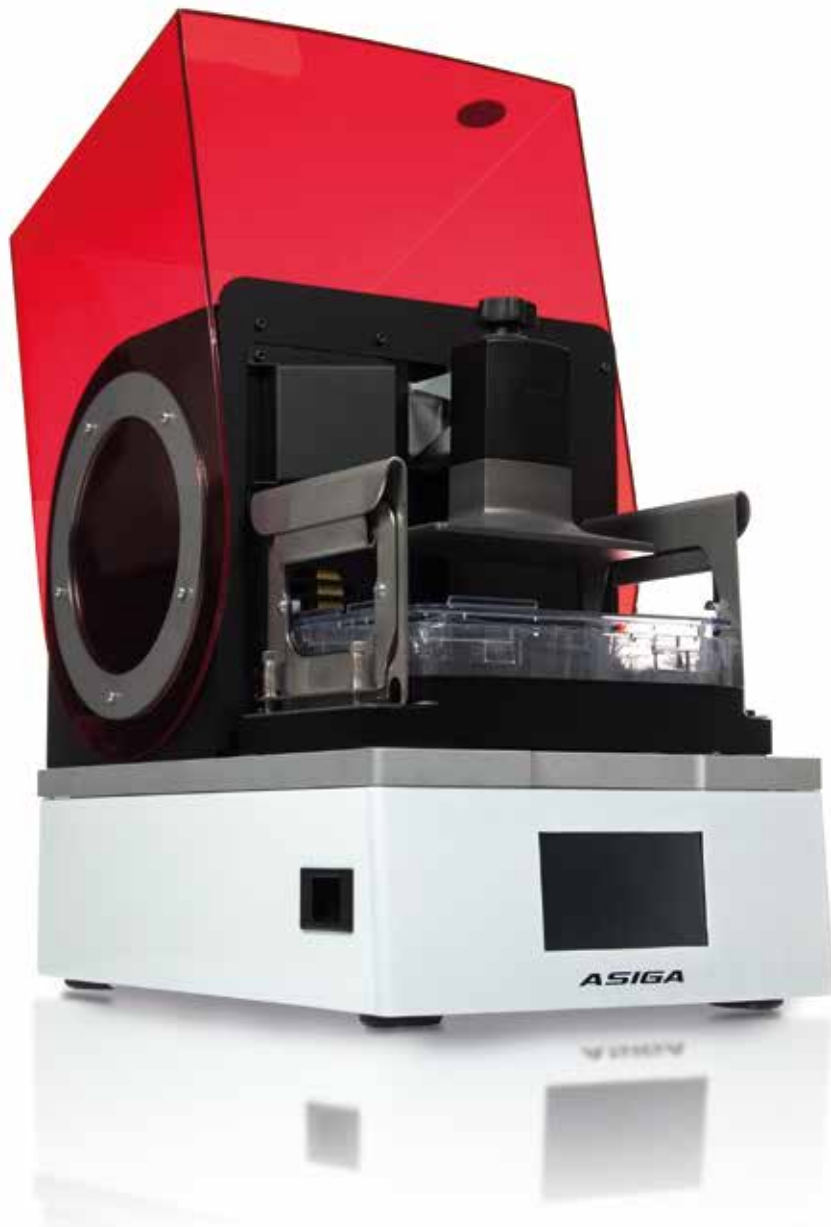

Entry-level printer with LCD technology

Asiga MAX™ LCD

The Asiga MAX™ LCD combines the ease-of-operation of the Asiga MAX™ with proven and economic LCD technology. The pixel matrix used for this printer is the LCD display with LED backlight. This technology is cost-effective, yet precise and reliable, turning the printer into an attractive entry-level printer.

Technical data

Dimensions (W x D x H): 260 x 380 x 370 mm

Build volume (X, Y, Z): 121 x 68 x 76 mm

Consistent data formats: STL, SLC, STM

Image technology: LCD

Pixel size: 47 µm

Light source: LED

Wavelength: 405 nm

/// Asiga MAX™ LCD

6530.1
1 piece



Asiga MAX™ Tray

The tray system of the Asiga MAX™ allows for easy changing and refilling of materials. Four trays with maximum print capacity of 1l, 2l, 5l or 10l and a maximum fill level of 300 to 400 ml per application are available. Equipped with RFID chip for recording the object volume generated during the print job. It is not possible to use the tray exceeding the maximum print volume.

/// 2l

6515.1
1 piece

/// 1l

6516.1
1 piece

/// 5l

6517.1
1 piece

/// 10l

6518.1
1 piece



New

Asiga PRO HD

The Asiga PRO HD is a large format floor-standing 3D printer which combines proven industry-leading precision and a large build envelope with high-speed print capability for high printing volumes. It is equipped with 385 nm DLP technology and a high power UV LED light source, featuring CNC machined calibration assembly, SPST[™] Smart-Positioning-System technology and process monitoring technologies for repeatable precision and accurate layer formation. Various ease-of-operation features like Asiga Composer software, touch screen display, simple user interface, Wifi and remote control via web interface are included as well.

Asiga PRO HD is available in three versions that differ in pixel resolution (65, 80 or 100 μ m) and thus build volume.

Technical data

Image technology: DLP

Light source: high power UV LED projector with HD chip

Wavelength: 385 nm

Pixel size: 65, 80 or 100 μ m

Build volume (X, Y, Z): 125 x 70 x 200 mm (Asiga PRO HD65) /
153.6 x 86.4 x 200 mm (Asiga PRO HD80) /
192 x 108 x 200 mm (Asiga PRO HD100)

Layer thickness: 10 -150 (continuous adjustment with accuracy of 1 μ m)

File input: STL, SLC, STM

Voltage source: 100 - 240 V, 50/60 Hz

Power: 500 W

Dimensions (D x W x H): 420 x 465 x 1370 mm

Weight: 75 kg

// Asiga PRO HD65	6535.1 1 piece
// Asiga PRO HD80	6536.1 1 piece
// Asiga PRO HD100	6537.1 1 piece



New

Asiga PRO 4K

Asiga PRO 4K is a floor-standing 3D printer utilizing the latest DLP imaging technology and combining precision, reliability and speed for high print volumes in the most demanding production applications. Compared to Asiga PRO HD, this model is equipped with a 4K projector, allowing even larger build volumes at the same pixel resolution. Besides the proven SPST[™] Smart Positioning System and various technologies for process monitoring, Asiga PRO 4K offers familiar ease-of-operation features like Asiga Composer software, touchscreen display, simple user interface, WiFi and remote control via web interface.

Asiga PRO 4K is available in two versions that differ in pixel resolution (65 or 80 µm) and thus build volume.

Technical data

Image technology: DLP

Light source: high power UV LED projector with 4K chip

Wavelength: 385 nm

Pixel size: 65 or 80 µm

Build volume (X, Y, Z): 176 x 99 x 200 mm (Asiga PRO 4K65) /
217 x 122 x 200 mm (Asiga PRO 4K80)

Layer thickness: 10 -150 (continuous adjustment with accuracy of 1 µm)

File input: STL, SLC, STM

Voltage source: 100 - 240 V, 50/60 Hz

Power: 500 W

Dimensions (D x W x H): 420 x 465 x 1370 mm

Weight: 75 kg

// Asiga PRO 4K65

6538.1
1 piece

// Asiga PRO 4K80

6539.1
1 piece



New

IMPRIMO® Clean

Cleaning unit for gentle cleaning of 3D printed objects. The IMPRIMO® Clean creates a circular flow in the cleaning solution to minimize the risk of micro-cracks in the part surface, thus increasing its quality. Different cleaning programs allow for precise matching with the selected material class and choice of the cleaning agent. The easy removable insert enables quick and clean replacement of the cleaning solution. The cleaning unit will be able to communicate with an app via a wireless network, to allow for complete documentation of the cleaning process.

Technical data

Voltage: 100 - 230 V

Dimensions: 404 x 404 x 240 mm

Cleaning chamber: 140 x 140 x 100 mm (3,5 l capacity)

Software: Linux OS

Network compatibility: Wifi, Ethernet

Touch panel: 7"

// IMPRIMO® Clean

6534.1
1 piece



High cleaning power

IMPRIMO® Cleaning Liquid

Water-soluble cleaning agent for removal of resin residues on 3D printed objects. For use in ultrasonic baths, ultra-filterable and non-explosive. Cleaning effect up to 5 times higher than isopropanol.

// IMPRIMO® Cleaning Liquid

6533.1
1 l



With protective gas (nitrogen)

IMPRIMO® Cure

Light oven for the polymerization of 3D printed objects with LED exposure technology and protective gas device (nitrogen), avoiding the formation of an inhibition layer. Control of exposure parameters via touch screen. Built-in sensors measure the protective gas flow in the polymerization chamber and inform the user about the state of the light source. Communication of the Light Oven with an app via a wireless network will be possible for the transmission of QM relevant data such as exposure programs.

Technical data

Voltage: 220 V

Wavelength: 365 / 405 nm

Light source: LED

Dimensions: 405 x 210 x 430 mm

UV-chamber: 167 x 115 x 105 mm

Network compatibility: Wifi

Sensor: gas pressure, UV sensor

Working pressure: 1.8 bar

// IMPRIMO® Cure

6532.1
1 piece



3D Model insulation

Insulation for 3D models when processing cold-curing resin, such as STEADY-RESIN S. Application with enclosed brush provides optimum insulation, suitable for models generated with 3D printers.

// 3D Model insulation

6510.1
65 ml



IMPRIMO® LC resins for 3D printing

Together with pro3dure medical GmbH we have developed an extensive portfolio of light-curing building materials based on methacrylate covering a variety of dental applications. Materials are matched to the ASIGA MAX™ 3D printer and suitable for either DLP systems with a light source of 385 nm or LCD systems with a light source of 405 nm. Please refer to the table in the annex for the technical data of the materials.



New colours

IMPRIMO® LC Model

Light-curing resin at the base of methacrylate for fabrication of high-precision dental models with smooth surfaces. Available in three colours for orthodontic and prosthetic applications, adapted to DLP systems with a light source of 385 nm or LCD systems with a light source of 405 nm.

// ivory, DLP / 385 nm	6502.1 1 kg
// grey, DLP / 385 nm	6504.1 1 kg
// beige, DLP / 385 nm	6505.1 1 kg
// beige, LCD / 405 nm	6561.1 1 piece



IMPRIMO® LC Splint

Light-curing resin at the base of methacrylate for fabrication of high-precision, transparent occlusal splints and surgical drilling guides. When cured, the resin is characterised by relative flexibility and provides high wearing comfort, reduced susceptibility to breakage and excellent polishing properties. Contains no diluting monomers, compatible with DLP printing systems with 385 nm light source.

// transparent, DLP / 385 nm	6503.1 1 kg
------------------------------	-----------------------

CE 0481



IMPRIMO® LC Impression

Light-curing resin at the base of methacrylate for fabrication of individual functional trays and bases for bite registrations, neon orange. Compatible with DLP systems with a light source of 385 nm.

// orange, DLP / 385 nm	6506.1 1 kg
-------------------------	-----------------------

CE



CAD / CAM

IMPRIMO® LC IBT

Light-curing, flexible resin for fabrication of transfer masks in the indirect bonding technique, transparent. Compatible with DLP systems with a light source of 385 nm.

// transparent, DLP / 385 nm

6508.1
1 kg

CE



IMPRIMO® LC Cast

Light-curing resin, castable and burning out residue-free, for fabrication of dental casting objects, red. Adapted to DLP systems with a light source of 385 nm or LCD systems with a light source of 405 nm.

// red, DLP / 385 nm

6507.1
1 kg

// red, LCD / 405 nm

6562.1
1 piece

IMPRIMO® LC Gingiva

Light-curing, flexible resin for fabrication of gingival masks, rose. Compatible with DLP systems with a light source of 385 nm.

// rose, DLP / 385 nm

6509.1
1 kg



New: for functional try-ins

IMPRIMO® LC Try-In

Light-curing basis material at the base of methacrylate for functional try-ins of digitally planned denture bases. For checking of bite registration and occlusion, available in tooth shades VITA classical A1, A2 and A3. Compatible with DLP systems with a light source of 385 nm.

// A1, DLP / 385 nm	6541.1 1 kg
// A2, DLP / 385 nm	6542.1 1 kg
// A3, DLP / 385 nm	6543.1 1 kg

CE



New: for denture bases

IMPRIMO® LC Denture

Light-curing resin at the base of methacrylate assigned to Class IIa of the MDD destined for fabrication of denture bases, available in three gingiva colour shades. All requirements for dental products relating to water absorption ($25.8 \mu\text{g}/\text{mm}^3$) and water solubility ($0.41 \mu\text{g}/\text{mm}^3$) according to ISO 20795-1: 2013 are met. Low shrinkage ($< 1\%$) guarantees perfect fit. Outstanding polishability, compatible with DLP printing systems with 385 nm light source.

// orange pink, DLP / 385 nm	6540.1 1 kg
// light pink, DLP / 385 nm	6547.1 1 kg
// deep pink, DLP / 385 nm	6548.1 1 kg

CE 0481



New: for temporary crowns and bridges

IMPRIMO® LC Temp

Light-curing resin at the base of methacrylate assigned to Class IIa of the MDD for fabrication of temporary crowns and bridges as well as mock-ups, characterized by high abrasion and breaking resistance. High aesthetics in tooth shades VITA classical A1, A2 and A3. The temporaries can be fastened with temporary cements. Compatible with DLP systems with a light source of 385 nm.

// A1, DLP / 385 nm	6527.1 1 kg
// A2, DLP / 385 nm	6528.1 1 kg
// A3, DLP / 385 nm	6529.1 1 kg

CE 0481



New: for long-term temporaries

IMPRIMO® LC Temp It

Light-curing resin at the base of methacrylate assigned to Class IIa of the MDD in long-term version – with higher filler content for fabrication of long-term temporaries such as crowns and bridges as well as mock-ups. High abrasion and breaking resistance and high aesthetics in tooth shades VITA classical A1, A2 and A3. The temporaries can be fastened with temporary cements. Compatible with DLP systems with a light source of 385 nm.

// A1, DLP / 385 nm	6544.1 1 kg
// A2, DLP / 385 nm	6545.1 1 kg
// A3, DLP / 385 nm	6546.1 1 kg

CE 0481



Prof. Alessandro Pozzi, Rome Italy



New: for implantology and surgery

IMPRIMO® LC MJF

Light-curing and hemocompatible resin at the base of methacrylate for fabrication of appliances in oral and maxillofacial surgery and implantology. Suitable for the usual sterilization methods such as plasma, autoclave, gamma radiation and ethylene oxide sterilization. This unique blood compatible material offers a range of applications with an extremely high standard of biocompatibility, such as for example surgical drilling templates or NAM-plates. Compatible with DLP systems with a light source of 385 nm.

// transparent, DLP / 385 nm	6526.1 1 kg
------------------------------	----------------

CE 0481



OnyxCeph3™ CA® SMART 3D

The independent software solution for digital planning of aligners and virtual bracket positioning with numerous interfaces to the practice software. An automatic control of transpositions during set-up is defined in the CA® CLEAR ALIGNER treatment philosophy and correspondingly reflected in the software. The control of the complete treatment process and value creation during all involved treatment steps remain in the hands of the user. Available as clinic or laboratory version with license for up to five workstations on the network and additional independent single-user license. One day software training included. The purchase of the CA® SMART 3D software is subject to certification.

For further information on training courses etc. please visit www.scheu-dental.com/en/scheu-academy/seminars.

System requirements

Network server and workstation with Intel 2.3 GHz (or higher), 8 GB RAM, 64 bit system, 200 GB HD space, operating system Windows 7 or higher/server OS, 1000 Mbps Ethernet, graphics card NVIDIA Ge-Force GTX 1 GTS or equivalent.

Function OnyxCeph3™ CA® SMART 3D	clinic	laboratory
Scanning		
Importing scan data	✓	✓
Starting the scan process	✓	✓
Interface to specified 3D scanners	✓	✓
Set-up planning/data processing		
Superposition of 3D data set	✓	✓
Possibility for corrections to already established set-ups	✓	✓
Creation of base moulds	✓	✓
Model labelling	✓	✓
Processing of 2D data sets	✓	✓
Processing of 3D data sets		✓
Virtual segmentation of teeth		✓
Control of set-ups using the CA® philosophy reflected in the software		✓
Digital bracket positioning		
Fabrication of digital bracket transfer masks		✓
Bracket positioning on facial-axis point		✓
Possibility for corrections to already positioned brackets	✓	✓
3D evaluations		✓
Exporting		
Generation of 3D reports	✓	✓
Exporting unchanged stl-data	✓	✓
Exporting customised set-ups as stl data		✓
Direct data export to Asiga Composer software	✓	✓
Administration		
Interface to administration software, e.g. Computer konkret	✓	✓
Archiving model data	✓	✓

OnyxCeph3™ CA® SMART 3D - clinic

Meets the demands of orthodontists for efficient support in daily practice routines. Enables features such as importing scan data or starting of scan processes, superposition of 3D data sets, creation of base moulds, labelling, exporting and archiving of model data.

/// OnyxCeph3™ CA® SMART 3D - clinic
License for up to five workstations in the network and independent single user, plus annual support fee

6512.1
1 piece

CE 0494



Available as add-on module

OnyxCeph3™ CA® SMART 3D - laboratory

Meets the demands of lab owners for precise planning, transpositions and control of digital aligner and multi-band solutions. Enables processing of 2D and 3D data sets, virtual segmentation of teeth, digital bracket positioning and export of printing data.

For users of OnyxCeph3™ available as single module.

/// OnyxCeph3™ CA® SMART 3D - laboratory
License for up to five workstations in the network and independent single user, plus annual support fee

6513.1
1 piece

/// module
for OnyxCeph3™ users, plus annual support fee

6513.002
1 piece

CE 0494



Milling technology

Milling blank for thermoplastic splints

DURASPLINT® flex

MMA-free material for the fabrication of functional occlusal splints with thermoplastic memory effect. The material is flexible at body temperature, leading to an increased wearing comfort. At the same time, the material is characterized by a high restoring torque at room temperature, high breaking resistance, durability and permanent transparency. The unique manufacturing process guarantees permanent tastelessness of the finished splints. Available as milling blank in thicknesses of 16 and 20 mm and as cold-curing resin for use in the casting and pressing techniques.

/// 16 mm milling blank
Ø 98.5 mm

3619.1
1 piece

/// 20 mm milling blank
Ø 98.5 mm

3620.1
1 piece

CE 0481



Learn more:





Dental Sleep Medicine

More quality of life.

We assure restful sleep. Trust in the market leader in dental sleep medicine. The IST® and TAP® appliances set the standard for successful treatment of snoring and sleep apnoea. We recommend our

SCHEU-ACADEMY courses on indication and fabrication of these devices.

IST® and OPM	84	Bite registrations and occlusion trainer	92
TAP® Anti-snoring devices	86	Accessories	94



IST® Kit HF 9

Intra-oral anti-snoring device, pressure-moulded. Connection between upper and lower jaw is achieved by continuously adjustable HF telescope. Lower jaw and tongue are advanced by protrusion.

// IST® Kit HF 9

incl. 2 telescopes, 4 DURAN® (2.0 mm), 4 ISOFOLAN®, DURASPLINT® resin, 4 fastening elements with O-ring, 4 SCHEU-Anchor, Alastik chain, silicone tube, security key, SD box for patient, occlusion trainer, 2 CETRON® cleaning powder bags of 15 g, instructions and patient information

5461.1
1 kit

CE 0044

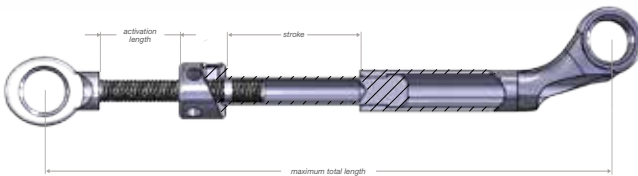

	Minimum length	Maximum length	Stroke	Length to be activated	$4 \times \frac{1}{4}$
HF 5	20 mm	28 mm	5 mm	3 mm	0.25 mm
HF 9	25 mm	39 mm	9 mm	5 mm	0.25 mm
HF 15	31 mm	51 mm	15 mm	5 mm	0.25 mm

Telescopes

Telescopes with limit stop, available in 3 sizes (HF 5, HF 9 and HF 15), continuously adjustable.

// HF 5

5449.1
1 pair

// HF 9

5454.1
1 pair

// HF 15

5444.1
1 pair

CE 0044

Positioning aid for IST® (12° / 0°)

For simple and correct positioning of the IST® fastening elements.

// Positioning aid for IST® (12° / 0°)

5469.1
1 piece



Fastening elements for IST® appliance

With stable retention, come with O-rings.

// Fastening elements for IST® appliance
incl. silicone tube

5468.1
4 pairs

CE 0044



Fastening elements for IST® and Herbst appliances

With stable retention, come with hexagon screws.

// Fastening elements for IST® and Herbst appliances
incl. silicone tube

5457.1
4 pieces

CE 0044



Hexagon socket screws

Spare screws for fastening elements.

// Hexagon socket screws
for IST® appliance

5458.1
4 pieces

CE 0044



O-Rings

Replacement O-rings for IST® appliance, transparent.

// O-Rings
for IST® appliance

5466.1
10 pieces

CE 0044



OPM Kit

For simple fabrication of a pressure moulded OPM protrusion splint in snoring therapy. Activation is done in 1 mm steps by replacing the plastic bars on both sides.

// OPM Kit
incl. 6 pairs of plastic bars (25 - 30 mm long), 4 fastening
elements with O-rings, 1 bag CETRON® cleaning powder of 15 g,
occlusion trainer, silicone protection tube

5495.1
1 kit

CE



TAP® Anti-snoring devices

Intraoral devices have become a renowned supplement in the treatment of snoring and mild to moderate forms of sleep apnea and even represent an alternative to the treatment with respiratory masks (CPAP). TAP® splints meet the requirements of therapists as well as of patients concerning an effective treatment device in dental sleep medicine.

TAP® kits, components and accessories (except TAP® PAP and myTAP™) are exclusively delivered to certified participants of the TAP® technical course.



TAP® Standard Kit

Thornton Adjustable Positioner (TAP®), enables a controlled and effective treatment of snoring and sleep apnoea. The TAP® splint has been developed by the American dentist and engineer Dr. Keith Thornton.

// TAP® Standard Kit 9000.1
 incl. TAP® threaded rod, hexagon wrench, occlusion trainer, 5 bags 1 kit
 CETRON® cleaning powder of 15 g, SD box blue and patient
 information

CE



TAP®-T Kit

Developed on the basis of TAP® Standard in slender design. Nickel-free components for optimum bio-compatibility. Upper protrusion adjustment device can be continuously activated up to 7 mm. Reactivation is possible.

Also available as pre-assembled set (REF 9030.2).

// TAP®-T Kit 9030.1
 comes with TAP® case, upper protrusion adjustment device made 1 kit
 of titanium, lower guiding device made of nickel-free CoCr-alloy,
 mounting aid, activation key, occlusion trainer, 5 bags of 15 g
 CETRON® cleaning powder, CETRON® cleaning box and patient
 information

// TAP®-T, pre-assembled kit 9030.2
 comes with TAP® case, upper protrusion adjustment device made 1 piece
 of titanium, pre-assembled with sticky wax, lower guiding device
 made of nickel-free CoCr-alloy, mounting aid, activation key,
 occlusion trainer, 5 bags of 15 g CETRON® cleaning powder,
 CETRON® cleaning box and patient information

CE



TAP®-T Reverse Kit

The TAP®-T Reverse device incorporates a reduced upper protrusion adjustment device made of titanium. It has been specifically designed for patients with deep bite. Lower protrusion is adjusted by activation key (palatal), as this reduced adjustment device can be inserted behind the upper incisors in the DURASOFT® splint. Reactivation is possible.

Also available as pre-assembled set (REF 9050.2).

// TAP®-T Reverse Kit **9050.1**
1 kit
comes with TAP® case, small upper protrusion adjustment device made of titanium, lower guiding device made of nickel-free CoCr-alloy, mounting aid, activation key, occlusion trainer, 5 bags of 15 g CETRON® cleaning powder, CETRON® cleaning box and patient information

// TAP®-T Reverse, pre-assembled kit **9050.2**
1 kit
comes with TAP® case, upper protrusion adjustment device made of titanium, pre-assembled with sticky wax, lower guiding device made of nickel-free CoCr-alloy, mounting aid, activation key, occlusion trainer, 5 bags of 15 g CETRON® cleaning powder and patient information

CE



TAP®-T / TAP®-T Reverse Starter-Set

Simplified mounting thanks to combination of TAP®-T or TAP®-T Reverse upper protrusion adjustment device and TAP®-T lower guiding device, pre-assembled with sticky wax.

// TAP®-T Starter-Set **9031.1**
1 piece
set comes with TAP®-T positioning aid, pre-assembled with sticky wax, activation key, SD box blue, patient information

// TAP®-T Reverse Starter-Set **9051.1**
1 piece
set comes with TAP®-T Reverse positioning aid, pre-assembled with sticky wax, activation key, SD box blue, patient information

CE

The new TAP® generation

dreamTAP™

The dreamTAP™ splint is characterised by a guiding device implemented in the lower jaw, offering additional space for the tongue and thus higher wearing comfort. It is infinitely adjustable and has interchangeable hooks, enabling a protrusion adjustment of up to 15 mm and large lateral excursion. The components are from a nickel-free CrCo alloy fabricated by MIM (Metal Injection Molding) and thus exceptionally stable.

// dreamTAP™
incl. protrusion adjustment device, short and long hook, power distribution wire (0.8 mm) and guide wire (1.1 mm), adjustment key, key for hook changes, plastic profile, AM Aligners, storage box, patient instructions.

9060.1
1 kit

CE



For use in combined therapy

TAP® PAP

Comfortable nasal pillow mask designed for patients with low CPAP compliance. Since the TAP® PAP mask is anchored to the upper teeth with a special ThermAcryl™ mouthpiece, it is very stable, will not move or leak nor leave annoying marks on the nose and face. Lower jaw splint sold separately (TAP® PAP lower tray, REF 9074) for use in combined therapy.

// TAP® PAP
comes with nasal pillow in small, medium and large

9073.1
1 piece

CE



TAP® PAP Lower Tray

Lower jaw protrusion splint for use with TAP® PAP in combined therapy. An advancement of the lower jaw can reduce the pressure exercised by the mask. Comes with lower protrusion splint, screw, AM Aligner and instruction.

// TAP® PAP Lower Tray

9074.1
1 piece

CE



With labial shield

myTAP™

Diagnostic testing appliance for getting acquainted with the simple and patient-friendly treatment of snoring and sleep apnoea. Metal-free and easy adjustable trays enable protrusion up to 20 mm, assuring considerable lateral excursion.

// myTAP™ **9070.1**
upper and lower jaw splint, incl. nut, labial shield, storage box, AM
Aligner and instructions 1 piece

CE



TAP® Splint case for patients

Zippered case for storing and carrying TAP® and TAP®-T splints.

// TAP® Splint case for patients **9082.1**
1 piece



TAP®-T Mounting device

Auxiliary for easy mounting of TAP®-T upper protrusion adjustment device and TAP®-T lower guiding device.

// TAP®-T Mounting device **9039.1**
5 pieces



TAP®-T Matrix

Reusable auxiliary element made of heat-resistant silicone for efficient fabrication of the sticky wax spacer. Makes sure the TAP®-T titan hook runs free in the guiding device in the lower splint.

Not for use with TAP®-T XL lower guiding device.

// TAP®-T Matrix **9037.1**
2 pieces



TAP® Components

TAP® Front assembly

Protrusion adjustment device for TAP® Standard, comes with hexagon socket wrench.

// TAP® Front assembly
incl. hexagon socket wrench

9010.1
1 piece



TAP® Mounting device

For easy and correct positioning of the front assembly, comes with socket wrench.

// TAP® Mounting device
incl. socket wrench

9016.1
1 piece



TAP® Lingual bar

Replacement TAP® lingual bar for TAP® Standard.

// TAP® Lingual bar

9013.1
1 piece



TAP3® Closed hook

Replacement u-hook for TAP® Standard.

// TAP® Closed hook (u-hook)

9012.1
1 piece



TAP® Cover plate

Replacement plate set for the TAP® Standard front assembly after adjustment of protrusion.

// TAP® Cover plate
incl. 2 screws and hexagon key

9015.1
1 piece



TAP® Locator

Replacement locator, suitable for TAP® Standard.

// TAP® Locator

9014.1
1 piece



TAP®-T Upper protrusion adjustment device

Replacement protrusion adjustment device, allowing 7 mm protrusion.

// TAP®-T Upper protrusion adjustment device

9033.1
1 piece



TAP®-T Reverse Upper protrusion adjustment device

Replacement TAP®-T Reverse protrusion adjustment device, allowing 4 mm protrusion.

// TAP®-T Reverse Upper protrusion adjustment device

9053.1
1 piece



TAP®-T Lower guiding device

Replacement TAP®-T lower guiding device, suitable for TAP®-T and TAP®-T Reverse upper protrusion adjustment device.

// TAP®-T Lower guiding device

9032.1
1 piece



TAP®-T XL Lower guiding device

Increased version (2 mm additional mobility) for more wearing comfort. Can be used with TAP®-T and TAP®-T Reverse upper protrusion adjustment devices.

// TAP®-T XL Lower guiding device
incl. matrix

9029.1
1 piece



Bite registrations and occlusion trainer

Learn more:



Bite Fix®

Bite registration with reusable holder made of sterilizable plastic for the simple and precise registration of construction bites in anti-snoring therapy. The decentralized handle assures easy midline control and comes with fixing screw and mm-scale for control of protrusion adjustment.

// kit 5474.1
incl. 1 holder and 1 bite fork 1 kit

// bite forks 5475.1
10 pieces

CE



Suitable for model scanners

Bite Fix® Scan

Bite registration with reusable holder made of sterilizable plastic for the simple and precise registration of construction bites in anti-snoring therapy. The decentralized handle assures easy midline control and comes with fixing screw and mm-scale for control of protrusion adjustment. Fits into every model scanner due to a predetermined breaking point on the bite fork.

// kit 5492.1
incl. 1 holder and 1 bite fork 1 kit

// bite forks 5493.1
10 pieces

CE



New

Bite Fix® One

Bite Fix® bite registration as single-use product, for easy and precise registration of construction bites in the anti-snoring therapy. Non-reusable, not sterilisable.

// Bite Fix® One 5503.1
1 kit

CE



GEORGE GAUGE™ bite registration set

For registration of occlusion in snoring therapy and orthodontics. The bite registration is pre-adjusted using 2 or 5 mm bite forks.

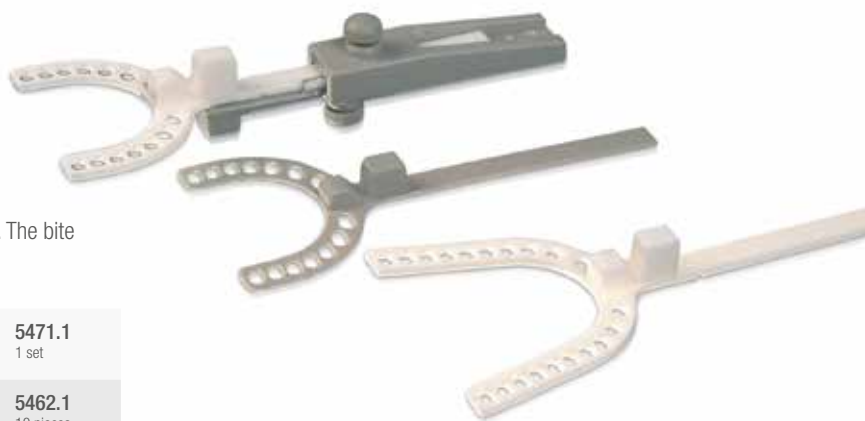

// GEORGE GAUGE™ bite registration set comes with 3 bite forks (1 for each size)	5471.1 1 set
// GEORGE GAUGE™ bite fork, 5 mm, white, large (L)	5462.1 10 pieces
// GEORGE GAUGE™ bite fork, 2 mm, grey, small (S)	5472.1 10 pieces
// GEORGE GAUGE™ bite fork, 5 mm, white, small (S)	5473.1 10 pieces

CE

AM Aligner

Thermoplastic occlusion trainer for condylar reposition after wearing protrusion splints during the night. The AM Aligner is heated and adapted to the patient's upper jaw by the clinician.



// AM Aligner	9072.1 10 pieces
---------------	----------------------------

CE

Occlusion trainer

Condylar reposition device for patients' training after wearing protrusion splints during the night.



// Occlusion trainer	5470.1 10 pieces
----------------------	----------------------------

CE

Accessories

Learn more:



CLEAR-BLOKKER®

Light-curing, high-transparent gel for building-up pressure moulded DURAN® splints, reinforced with DURASPLINT® LC. Gel is best suited for removal of air inclusions and insertion of canine guidance. Polymerisation in wavelength range 360–420 nm, for example with LC Mini Light or LC-6 Light Oven. Prior to processing, LC primer has to be applied to DURAN® splints.

4 x 1.5 g
incl. 2 cannula Ø 0.4 mm and 8 cannula Ø 0.9 mm

5261.1
1 piece



SD Cyano Veneer Fast / SD Pipettes

Fast-curing bonding agent, fluid and crystal clear, suitable for fixation of components when fabricating TAP® or IST® splints. Can also be used for secure adhesion of screws in sleep medicine and orthodontics.

Separately available SD pipettes ensure precise dosing of SD Cyano Veneer Fast by micro tip.

SD-Cyano Veneer Fast

3701.1
5 g

SD-Pipettes

3703.1
25 pieces



Activation key

Activation key for TAP®-T and TAP®-T Reverse protrusion adjustment device. Can also be used for IST® hexagon screws.

Activation key

9035.1
1 piece





CETRON® Care set

Hygienic and long lasting care and cleaning of splints, dentures, orthodontic plates, mouth guard and snoring appliances.

// CETRON® Care set
incl. cleaning box, brush and 5 bags CETRON® cleaning powder of 15 g

3236.1
1 set



CETRON® Care spray

Care and cleaning of splints, dentures, orthodontic plates, mouth guard and snoring appliances. Fresh lemon taste reduces typical monomer taste, ensuring highly polished appliances and high wearing comfort at the same time.

// CETRON® Care spray

3238.1
75 ml

CE

CETRON® Cleaning powder

Mild powder for long lasting care and cleaning of orthodontic plates, splints, dentures and sports mouth guards. To dissolve in 150 ml of water.

// German	3237.1 5 bags	3237.2 25 bags	3237.3 250 bags
// English	3239.1 5 bags	3239.2 25 bags	3239.3 250 bags





Pressure Moulding Technique



More than 50 years of competence and experience.

Tried and tested. Our pressure moulding material has been tested and approved in terms of cell biology according to the international standards DIN EN ISO 10993 and 7405. The wide range of material

offers you the right product for any application. A bar code is applied to each blank, making processing quick, easy and safe.

Pressure moulding material	98	Finishing and polishing	114
Resins, auxiliaries and accessories.....	109		

Pressure moulding material

Learn more:



BIOCRYL® C

Break-resistant acrylic material of pure PMMA, monomer-free, without allergenic irritants, bonds to acrylic.

Application

Immediate dentures, orthodontic plates and retainers

// 2.0 x 125 mm, clear	3147.1 10 pieces	3147.2 100 pieces
// 2.0 x 125 mm, red-transparent	3149.1 10 pieces	
// 2.0 x 125 mm, blue-transparent	3150.1 10 pieces	
// 2.0 x 125 mm, yellow-transparent	3151.1 10 pieces	
// 2.0 x 125 mm, rose-transparent	3152.1 10 pieces	3152.2 100 pieces
// 3.0 x 125 mm, clear	3153.1 10 pieces	3153.2 100 pieces

CE



BIOCRYL® Form X

Viscoplastic material, does not bond to acrylic, blue.

Application

Radiopaque material for the exact visualisation of the clinical situation in computer tomography. The material closely adapts to the tooth surface and its outline is sharply imaged.

// 1.5 x 125 mm, blue

3148.1
10 pieces

CE



DURAN®

Hard-elastic transparent material, bonds to DURASPLINT® and DURASPLINT® LC. Apply LC primer prior to using DURASPLINT® LC. Does not require pre-drying.

Application

Miniplast splints, occlusal splints, interim and fluorisation splints, X-ray templates, anti-snoring appliances, reinforced anterior section of mouth guards, temporary crowns and bridges.

// 0.4 x 125 mm	3470.1 10 pieces	
// 0.5 x 125 mm	3411.1 10 pieces	3411.2 100 pieces
// 0.625 x 125 mm	3409.1 10 pieces	3409.2 100 pieces
// 0.75 x 125 mm	3413.1 10 pieces	3413.2 100 pieces
// 1.0 x 125 mm	3415.1 10 pieces	3415.2 100 pieces
// 1.5 x 125 mm	3417.1 10 pieces	3417.2 100 pieces
// 2.0 x 125 mm	3419.1 10 pieces	3419.2 100 pieces
// 3.0 x 125 mm	3421.1 10 pieces	3421.2 100 pieces

CE



DURAN®+

Hard-elastic transparent material, bonds to DURASPLINT® and DURASPLINT® LC. Apply LC primer prior to using DURASPLINT® LC. With integrated insulation foil. Does not require pre-drying.

Application

Miniplast splints, occlusal splints, interim and fluorisation splints, X-ray templates, anti-snoring devices, temporary crowns and bridges.

// 0.4 x 125 mm	3472.1 10 pieces	
// 0.5 x 125 mm	3426.1 10 pieces	3426.2 100 pieces
// 0.625 x 125 mm	3428.1 10 pieces	3428.2 100 pieces
// 0.75 x 125 mm	3430.1 10 pieces	3430.2 100 pieces
// 1.0 x 125 mm	3432.1 10 pieces	3432.2 100 pieces
// 1.5 x 125 mm	3434.1 10 pieces	3434.2 100 pieces
// 2.0 x 125 mm	3436.1 10 pieces	3436.2 100 pieces

CE

DURAN®+ A2 pd

Proven DURAN® quality in aesthetic colour (VITA A2), with integrated insulation foil. Already pre-dried and vacuum sealed for instant use.

Application

Tooth coloured temporaries, splints for planning and demonstration for aligner treatments

0.5 x 125 mm	3422.1 10 pieces
0.75 x 125 mm	3423.1 10 pieces
0.625 x 125 mm	3424.1 10 pieces

CE



DURAN®+ white pd

Proven DURAN® quality in white (VITA OM1), with integrated insulation foil. Already pre-dried and vacuum sealed for instant use.

Application

Cosmetic splints

0.5 x 125 mm	3473.1 10 pieces
0.625 x 125 mm	3474.1 10 pieces
0.75 x 125 mm	3475.1 10 pieces
1.0 x 125 mm	3476.1 10 pieces

CE

DURASOFT® pd

Unbreakable, abrasion-resistant, transparent compound material with a hard and soft side. Hard side bonds to acrylic. Already pre-dried and vacuum-sealed for instant use.

Application

Miniplast splints, bruxism splints, occlusal splints, intra-oral anti-snoring devices

// 1.2 x 125 mm hard / soft: 0.7 mm / 0.5 mm	3342.1 10 pieces	3342.2 100 pieces
// 1.8 x 125 mm hard / soft: 0.9 mm / 0.9 mm	3388.1 10 pieces	3388.2 100 pieces
// 2.5 x 125 mm hard / soft: 1.6 mm / 0.9 mm	3387.1 10 pieces	3387.2 100 pieces
// 3.0 x 125 mm hard / soft: 2.1 mm / 0.9 mm	3341.1 10 pieces	
// 4.0 x 125 mm hard / soft: 3.1 mm / 0.9 mm	3345.1 10 pieces	

CE



DURASOFT® blue pd

The proven break and abrasion resistant material in blue-transparent colour. Already pre-dried and vacuum sealed for instant use.

Application

Specifically for simple fabrication of coloured intra-oral anti-snoring devices. Blue colour increases aesthetics.

// 1.8 x 125 mm hard / soft: 0.9 mm / 0.9 mm	3347.1 10 pieces
// 2.5 x 125 mm hard / soft: 1.6 mm / 0.9 mm	3348.1 10 pieces

CE

DURASOFT® seal

Pressure moulding material made of thermoplastic polyurethane for use with DURASOFT® pd. Forms a robust inner layer and provides high quality hard-soft splints with excellent resistance against discolouration. Available in clear, blue and magenta.

Application

Discolouration resistant inner layer for DURASOFT® pd splints. Specifically designed for long-term use splints such as intra-oral anti-snoring devices.

0.1 x 125 mm, magenta	3337.1 10 pieces
0.1 x 125 mm, clear	3338.1 10 pieces
0.1 x 125 mm, blue	3339.1 10 pieces

CE



BIOPLAST®

Soft-elastic rubber like material, does not bond to acrylic, clear transparent. Hardness Shore A: 85.

Application

Duplication moulds, mouth guard, bruxism splints, positioners, OSAMU-Retainer®

1.0 x 125 mm, square	3270.1 10 pieces	3270.2 100 pieces
1.5 x 125 mm	3183.1 10 pieces	3183.2 100 pieces
2.0 x 125 mm	3185.1 10 pieces	3185.2 100 pieces
3.0 x 125 mm	3187.1 10 pieces	3187.2 100 pieces
4.0 x 125 mm	3188.1 10 pieces	3188.2 100 pieces
5.0 x 125 mm	3374.1 10 pieces	

CE



BIOPLAST® bleach

Soft pliable rubber like material, best suited for fabrication of bleaching splints. Material does not bond to acrylic. Hardness Shore A: 92.

1.0 x 125 mm

3190.1
10 pieces

3190.2
100 pieces

CE

BIOPLAST® Color

Soft, pliable rubber like material, does not bond to acrylic. Hardness Shore A: 85.

Application

Coloured mouth guards, positioners

Color-Set	3271.1 10 pieces
3.0 x 125 mm, red	3282.1 10 pieces
3.0 x 125 mm, neon red	3352.1 10 pieces
3.0 x 125 mm, neon green	3353.1 10 pieces
3.0 x 125 mm, azure	3354.1 10 pieces
3.0 x 125 mm, red-transparent	3355.1 10 pieces
3.0 x 125 mm, blue-transparent	3356.1 10 pieces
3.0 x 125 mm, white	3445.1 10 pieces
3.0 x 125 mm, black	3448.1 10 pieces



CE

BIOPLAST® Multicolor

Soft, pliable rubber like material, does not bond to acrylic.
Hardness Shore A: 85.

Application

Coloured mouth guards, positioners

// 3.0 x 125 mm, Germany	3390.1 10 pieces
// 3.0 x 125 mm, France	3391.1 10 pieces
// 3.0 x 125 mm, Italy	3392.1 10 pieces
// 3.0 x 125 mm, Spain	3393.1 10 pieces
// 3.0 x 125 mm, Sweden	3394.1 10 pieces
// 3.0 x 125 mm, Brazil	3395.1 10 pieces
// 3.0 x 125 mm, Transylvania	3396.1 10 pieces
// 3.0 x 125 mm, Atlantis	3397.1 10 pieces
// 3.0 x 125 mm, White Dots	3398.1 10 pieces
// 3.0 x 125 mm, Green Dots	3399.1 10 pieces
// 3.0 x 125 mm, Multicolor Set	3400.1 10 pieces

CE



BIOPLAST® XTREME

BIOPLAST® XTREME material is ideally suited for simple and safe preparation of individual mouth guard. Hard V-shaped reinforcement layer (Shore A: 92) ensures additional protection in the anterior region, allowing precise positioning in the desired extension. Soft layer (Shore A: 85) can be used for lamination with BIOPLAST® or for insertion of the counter bite.

Only for MINISTAR® from 4/92 and BIOSTAR® from 4/99.

// 4.0 x 125 mm, red	3295.1 10 pieces
// 4.0 x 125 mm, blue	3296.1 10 pieces
// 4.0 x 125 mm, black	3297.1 10 pieces
// 4.0 x 125 mm, clear	3298.1 10 pieces
// 5.0 x 125 mm, red	3286.1 10 pieces
// 5.0 x 125 mm, blue	3287.1 10 pieces
// 5.0 x 125 mm, black	3288.1 10 pieces
// 5.0 x 125 mm, clear	3289.1 10 pieces

CE

BIOPLAST® XTREME Kit

Two different degrees of hardness in one pressure moulding blank thanks to the integrated reinforcement in the delicate anterior region. Absorbs hard and flat impacts in contact sports. V-shaped harder insert (Shore A: 92) for variable size of front tooth protection.

Kits come with 1 BIOPLAST® XTREME 5.0 x 125 mm, 1 bag of 15 g CETRON® cleansing powder, 1 BIOPLAST® insulating agent, retainer box.

Only for MINISTAR® from 4/92 and BIOSTAR® from 4/99.

// red	3283.1 1 kit
// blue	3284.1 1 kit
// black	3285.1 1 kit

CE



BIOPLAST® XTREME PRO Kit

For professional sports where hard and flat impacts often occur. Additional hard-elastic insert for integrated reinforcement in the anterior region.

Kits come with 1 BIOPLAST® XTREME 4.0 x 125 mm, 1 BIOPLAST® clear 2.0 x 125 mm, 1 DURAN® 0.75 x 125 mm, 1 bag of 15 g CETRON® cleansing powder, 1 BIOPLAST® insulating agent, retainer box.

Only for MINISTAR® from 4/92 and BIOSTAR® from 4/99.

// red	3292.1 1 kit
// blue	3293.1 1 kit
// black	3294.1 1 kit

CE



BRUX CHECKER® acc. to Prof. Sato

Foil with one-side colour coating for analysis and therapy planning in case of bruxism and CMD as well as for control and grinding of prosthetic restorations.

// 0.1 x 125 mm, red	3209.1 10 pieces
----------------------	---------------------

CE



IMPRELON®

Hard material, not elastic, bonds to acrylic.

Application

Material in clear and opaque for impression trays, material in white for bite registration.

// 2.0 x 125 mm, clear	3164.1 10 pieces	
// 3.0 x 125 mm, clear	3168.1 10 pieces	3168.2 100 pieces
// 3.0 x 125 mm, weiß	3274.1 10 pieces	
// 3.0 x 125 mm, opaque	3361.1 10 pieces	

CE



IMPRELON® S pd

Extremely break and abrasion resistant material. Already pre-dried and vacuum sealed for instant use.

Application

OSAMU-Retainer®, miniplast splints, retention splints

// 0.5 x 125 mm, clear	3320.1 10 pieces	
// 0.75 x 125 mm, clear	3322.1 10 pieces	3322.2 100 pieces
// 1.0 x 125 mm, clear	3324.1 10 pieces	3324.2 100 pieces
// 1.5 x 125 mm, clear	3326.1 10 pieces	
// 2.0 x 125 mm, clear	3328.1 10 pieces	
// 3.0 x 125 mm, clear	3330.1 10 pieces	

CE



OSAMU-Retainer® Kit

Transparent retainer acc. to Dr. Yoshii. Pressure-moulded using BIOPLAST® 1.5 mm and IMPRELON® S pd 0.75 mm and OSAMU Bond for optimal compound of material. OSAMU-Retainer® Kit for fabrication of 10 retainers. All components also available separately.

// OSAMU-Retainer® Kit 10x IMPRELON® S pd (0.75 x 125 mm), 10x BIOPLAST® (1.5 x 125 mm), 10 ml OSAMU-bond	3242.1 1 kit
---	------------------------

CE



COPYPLAST®

Visco-plastic material, does not bond to acrylic, opaque.

Application

Duplication moulds, bleaching splints, bracket transfer masks, copings, moulds for temporary crowns and bridges

// 0.5 x 125 mm	3177.1 10 pieces	3177.2 100 pieces
// 0.75 x 125 mm	3169.1 10 pieces	3169.2 100 pieces
// 1.0 x 125 mm	3179.1 10 pieces	3179.2 100 pieces
// 1.5 x 125 mm	3175.1 10 pieces	3175.2 100 pieces
// 2.0 x 125 mm	3181.1 10 pieces	3181.2 100 pieces

CE



COPYPLAST® C

Transparent, visco-elastic material, unbreakable and abrasion resistant, does not bond to acrylic.

Application

Long term splints and retainers, orthodontic splints

// 1.0 x 125 mm	3403.1 10 pieces	3403.2 100 pieces
-----------------	---------------------	----------------------

CE

HARDCAST®

Hard-elastic material, does not bond to acrylic, combustible leaving no residue, opaque.

Application

Copings, spacer foil for bleaching splints

// 0.4 x 125 mm	3194.1 10 pieces
// 0.6 x 125 mm	3195.1 10 pieces
// 0.8 x 125 mm	3200.1 10 pieces

CE



ISOFOLAN®

Foil ensures optimum insulation for plaster against resin in the pressure moulding technique. Best suited as insulation foil when pressurising hard-elastic material for splints.

0.1 x 125 mm

3207.1
100 pieces



Spacer foil

For fabrication of copings made of HARDCAST®, has to be removed before embedding the model, clear.

0.1 x 125 mm

3202.1
100 pieces



Skin packaging

Protection packaging for sending out high quality models, consisting of cardboard and coating foil.

Skin packaging

3206.1
100 pieces



Coating foil

Protection cover for study and orthodontic models.

0.15 x 125 mm

3203.1
100 pieces

Resins, auxiliaries and accessories

Learn more:



BLUE-BLOKKER®

Light-curing, blue-transparent blocking-out and modelling putty with optimum flow properties. For fabrication of space holders for bleaching splints and medical trays as well as for sealing and blocking set-up models. Burns without leaving any residue, can therefore also be used in prosthetics for the fabrication of fixed and removable prostheses. Telescopic models are stable and can be withdrawn without tension. Curing in the wavelength range of 380-470 nm.

4 x 1.5 g
incl. 2 cannula Ø 0.6 mm and 8 cannula Ø 0.9 mm

5261.1
1 piece



CLEAR-BLOKKER®

Light-curing, high-transparent gel for building-up pressure moulded DURAN® splints, reinforced with DURASPLINT® LC. Gel is best suited for removal of air inclusions and insertion of canine guidance. Polymerisation in wavelength range 360–420 nm, for example with LC Mini Light or LC-6 Light Oven. Prior to processing, LC primer has to be applied to DURAN® splints.

4 x 1.5 g
incl. 2 cannula Ø 0.4 mm and 8 cannula Ø 0.9 mm

5271.1
1 piece

CE



Cannula

For use with BLUE-BLOKKER® and CLEAR-BLOKKER.

Ø 0.4 mm

5277.1
5 pieces

Ø 0.9 mm

5278.1
5 pieces



SIL-KITT

Permanently plastic silicone, used specifically for blocking-out undercuts when fabricating pressure moulded splints, anti-snoring and orthodontic appliances.

red

3442.1
150 g

transparent

3443.1
150 g



Blocking-out putty

Permanently plastic putty for blocking-out large-scale undercuts.

// Blocking-out putty

3220.1
250 g



BIOPLAST® Insulating agent

Insulation for plaster models when using BIOPLAST® material for fabricating positioners and mouth guards. BIOPLAST® insulating agent provides absolute transparency and smooth inner surfaces. Also available in practical 100 ml applicator bottle for quick and non-drip insulation of plaster models.

// BIOPLAST® Insulating agent
applicator bottle with 3 tips

3166.1
100 ml

// BIOPLAST® Insulating agent

3189.1
500 ml



BIOCRYL® Resin

Special orthodontic acrylic for attaching clasp arms and relining expansion screws when pressure-moulding retention and expansion plates using BIOCRYL® C. Material polymerises during the cooling phase in the pressure moulding unit. No need for time-consuming polymerisation in pressure pot.

// monomer

3218.1 **3218.2**
0.25 l 0.5 l

// polymer

3221.1 **3221.2**
400 g 1 kg

CE



DURASPLINT®

High-transparent cold-cure resin specifically designed for fabricating occlusal splints with adjusted occlusion. Very simple to use, little shrinkage, optimised trimming.

// kit
incl. 200 g polymer and 100 ml monomer, mixing
and dosing cup, 20ml orthodontic insulating agent
incl. brush, pipette, glass spatula and detailed
instructions

3257.1
1 kit

// polymer

3258.1 **3258.2**
200 g 400 g

// monomer

3259.1 **3259.2**
100 ml 0.25 l

CE





DURASPLINT® flex

The MMA-free, self-curing splint material DURASPLINT® flex with thermoplastic memory effect for use in casting and pressing techniques. The material is flexible at body temperature, leading to an increased wearing comfort. At the same time, the material is characterized by a high restoring torque at room temperature, high breaking resistance, durability and permanent transparency. Available as kit and in three pack sizes matching the mixing ratio, also as milling blank in thicknesses of 16 and 20 mm.

No hazardous material according to transport regulations.



// kit
incl. 180 g polymer and 130 g monomer, mixing and dosing cup, pipette, glass spatula and detailed instructions

3610.1
1 kit

// polymer

3611.1
180 g

3611.2
340 g

3611.3
800 g

// monomer

3612.1
130 g

3612.2
255 g

3612.3
600 g

CE 0481



DURASPLINT® LC

Light-curing, transparent resin, specifically designed for the adjustment of DURAN® splints with a minimal thickness of 1.5 mm. Doesn't require curing in autoclave. For polymerisation, we recommend using the LC 6 light oven with pre-set polymerisation times of 5 or 10 min. Curing in the wavelength of 350 – 450 nm. Prior to processing, LC primer has to be applied to DURAN® splints.

No yellow discolouration of material after light-curing.

// kit
3 bars (38 g in total) DURASPLINT® LC, 1.5 g CLEAR BLOKKER® with 2 cannula, 10 ml LC primer with brush, 10g LC insulation, 1 LC bur A, B and C each, 1 SD polishing paste A and B each, 5 SD polishing brushes, SD felt discs and SD high-gloss polishing mops with mandrel

3256.1
1 kit

// 3 bars, 38 g
W x L x H: 32 x 120 x 8 mm

3261.1
1 piece

3261.2
10 pieces

CE

LC Primer

Light-curing primer for pre-treating DURAN® splints before adjusting them with DURASPLINT® LC or CLEAR BLOKKER®. For polymerisation, we recommend using the LC 6 Light Oven with pre-set polymerisation times of 5 or 10 min. Curing in the wavelength of 350 – 450 nm.

LC Primer
with brush

3263.1
10 ml

CE



LC Insulation

Facilitates modelling DURASPLINT® LC on DURAN® splints. Ensures clean and neat working results with smooth surfaces, considerably simplifying finishing.

LC Insulation

3266.1
10 g



OSAMU-Bond

Bonding agent for optimum compound of BIOPLAST® and IMPRELON® S pd in the pressure moulding technique.

OSAMU-Bond

3246.1
10 ml

CE



Impression tray handles

Stable, handy plastic handles which can be fixed to tray with cold cure resin and individually formed by heating.

Impression tray handles

3216.1
10 pieces

3216.2
100 pieces

CE



Foam discs

Foam discs can be used as space holder and insulation for pressure moulded impression trays, providing retention to impression material.

Foam discs

3444.1
10 pieces



Stainless steel pellets

Stainless steel pellets, highly polished by galvanic treatment, for embedding models in pressure moulding machines. Thanks to the cylindrical pellet shape, models are securely positioned and can't be pressed into the pellets.

// Stainless steel pellets

3222.1
1 kg



Pellet cover

Used for covering stainless steel pellets while pressurising splints. Cover is reusable and avoids adhesion of pellets to the heated soft material.

// large

3006.1
5 pieces

// small

3007.1
5 pieces



Pellet brush

Pellet brush with integrated magnet for quick removal of pellets and lifting the model platform from the model cup.

// Pellet brush

3136.1
1 piece



Model platform

Model platform with 85 mm diameter provides increased surface for dental arch models made of resin and hard plaster, preventing the model from getting pressed into the stainless steel pellets.

// Ø 85 mm

3134.1
1 piece



Heating support

Can be attached directly to the heater when fabricating positioners and mouth guard, providing the optimum distance between model and heater when heating the occlusal surfaces and for compound of upper and lower splint. For BIOSTAR® and MINISTAR S®.

Dimensions (W x H x D): 190 x 160 x 70 mm

// Heating support

3452.1
1 piece



Finishing and polishing

Learn more:



SD-Foil scissors A

SD foil scissors A are delicately made of a high-grade auto-clavable stainless steel alloy. For better handling, scissors are laterally curved. Micro serration prevents slipping.

// SD-Foil scissors A

3460.1
1 piece



SD-Foil scissors B

SD foil scissors B are robust and durable for cutting splints or inserting cuts into splints after pressurising.

// SD-Foil scissors B

3461.1
1 piece



Finishing set

Set containing eight grinding instruments for cutting, trimming and finishing of soft-elastic and hard-elastic material. With color coding for easy identification.

// Finishing set

3378.1
1 piece

Set comes with one each cutting bur, finishing bur, HM carbide bur, HM tricutter fine, BIOPERM trimmer, POLYFIX, OSAMU polisher, DIMO[®]PRO SLIM and dressing stone.



LC-Bur

Specifically designed for finishing cold cure resin or light cured adjustments on splints. Allows neat cutting without clogging and leaving any residue. LC bur A comes in conical form for specific finishing or occlusal grinding. LC bur B is pear-shaped, ensuring very smooth grinding surface patterns when it comes to larger surfaces and LC bur C comes in bud form for quick and uniform removal of roughness.



Finishing bur

Square cutting bur made of special soft alloy that won't damage clasp wires.



HM-Tricutter fine

Fine triangular bur for interdental finishing of splints.



HM-Carbide cutter

Triangular carbide cutting bur for quick, neat cutting of hard pressure moulding material.



Cutting bur

Spiral cutting bur for quick, neat cutting of hard pressure moulding material.



// LC-Bur A maximum rotational speed: 20,000 r/min	3267.1 1 piece
// LC-Bur B maximum rotational speed: 20,000 r/min	3268.1 1 piece
// LC-Bur C maximum rotational speed: 20,000 r/min	3265.1 1 piece
// Finishing bur (red) maximum rotational speed: 25,000 r/min	3377.1 6 pieces
// HM-Tricutter fine (green) maximum rotational speed: 7,500 r/min	3370.1 6 pieces
// HM-Carbide cutter (yellow) maximum rotational speed: 7,500 r/min	3369.1 6 pieces
// Cutting bur maximum rotational speed: 25,000 r/min	3214.1 6 pieces

OSAMU Polisher

Finishing and polishing of soft-elastic and compound material.



POLYFIX

For trimming and final polishing of soft-elastic and compound material, brown. The discs should be shaped before use with a sharpening stone.



BIOPERM® Trimmer

For grinding and finishing soft-elastic and sandwich material, blue.



// OSAMU Polisher, grey maximum rotational speed: 15,000 r/min	3247.1 2 pieces
// POLYFIX, on mandrel maximum rotational speed: 25,000 r/min	3371.1 1 piece
// POLYFIX, discs maximum rotational speed: 25,000 r/min	3372.1 6 pieces
// BIOPERM® Trimmer, blue maximum rotational speed: 25,000 r/min	3226.1 2 pieces

DIMO®

Stable and flexible trimming wheels with prolonged processing time, three types of grains, incl. mandrel.

Application

Trimming and initial polishing of elastomer, sandwich material, mouth guard and orthodontic appliances.

// brown / coarse, incl. 1 mandrel maximum rotational speed: 10,000 r/min	3382.1 10 pieces	3382.2 50 pieces
// green / medium, incl. 1 mandrel maximum rotational speed: 10,000 r/min	3383.1 10 pieces	3383.2 50 pieces
// maroon / fine, incl. 1 mandrel maximum rotational speed: 10,000 r/min	3384.1 10 pieces	3384.2 50 pieces
// mandrel	3380.1 10 pieces	



DIMO® PRO / DIMO® PRO SLIM

Trimming wheel made of special elastomer with fine fibrous structure, extremely long working time, incl. mandrel. The discs should be shaped before use with a sharpening stone.

Application DIMO®PRO

For finishing large-scale marginal areas and for final and high-gloss polishing of splints, positioners, mouth guard and orthodontic appliances. Provides highly-polished rims and uniform surfaces of hard/soft compound material.

Application DIMO®PRO SLIM

For finishing splints, specifically in the area of ligaments and interdentially.



// DIMO®PRO, Ø 24 x 6 mm, incl. 1 mandrel maximum rotational speed: 10,000 r/min	3381.1 10 pieces
// DIMO®PRO SLIM, Ø 24 x 4 mm, incl. 1 mandrel maximum rotational speed: 10,000 r/min	3376.1 10 pieces

SD-Polishing brush

High-quality goat hair brush with micro fibre insert, for use in combination with SD polishing pastes A and B for polishing adjusted splints and orthodontic appliances.

SD-Polishing mop for high gloss

Extra soft mop structure for finishing and high-gloss polishing of built-up splints and orthodontic appliances.

SD-Felt wheel

For use in combination with SD polishing pastes when polishing built-up splints and orthodontic appliances.



// SD-Polishing brush, with mandrel maximum rotational speed: 5,000 r/min	3712.1 5 pieces
// SD-Polishing mop for high gloss, with mandrel maximum rotational speed: 2,500 r/min	3714.1 5 pieces
// SD-Felt wheel, with mandrel maximum rotational speed: 5,000 r/min	3713.1 5 pieces

SD-Polishing paste

Specifically designed for finishing (SD polishing paste A) and for high-gloss polishing (SD polishing paste B) of splints, adjusted with DURASPLINT® or DURASPLINT® LC. Can also be used for polishing orthodontic appliances.

// A (for finishing)	3710.1 60 g
// B (for high-gloss polishing)	3711.1 100 g

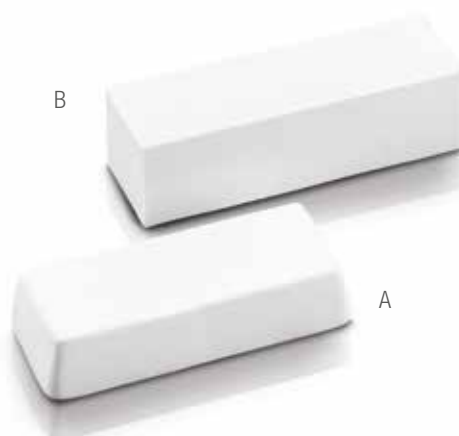

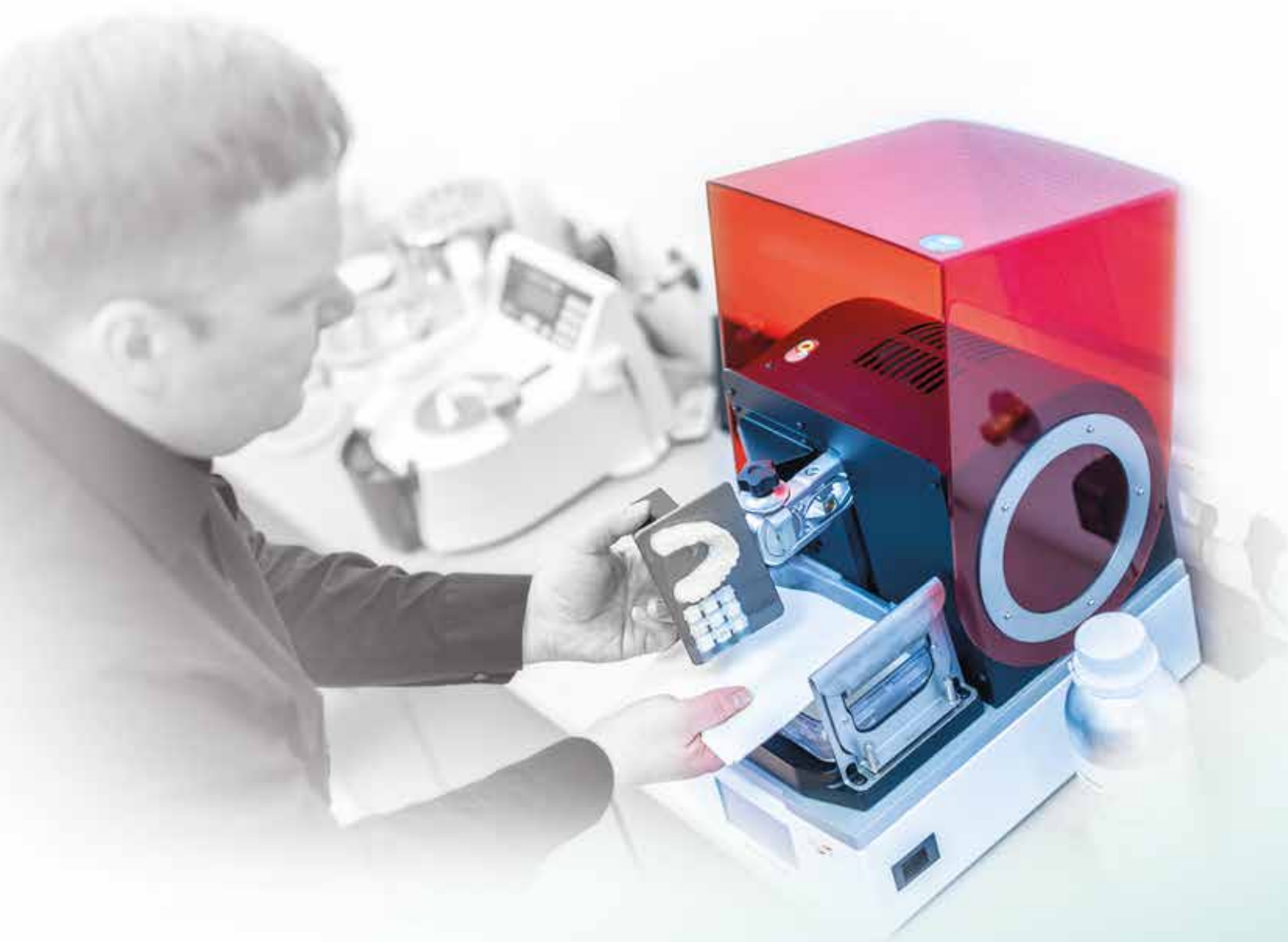



Laboratory equipment

We are setting benchmarks!

We are setting benchmarks, instead of just meeting standards.
 From O-ring to the microprocessor control – our specialists in the equipment manufacturing are well versed. All parts are manufactured

with maximum precision and attention to detail, which is why our pressure moulding units are delivered with a three-year warranty.

3D Printing	120	Pressure moulding technique.....	126
Light curing	125	Auxiliaries.....	128



Asiga MAX™

With DLP technology and maximum ease of use, the Asiga MAX™ printer allows for fast, precise and efficient operation. The built-in LCD panel with touch function displays the information on the current construction process and allows interactive control of the printer. The light sensor provides consistent projector performance and uniform resin curing, the smart positioning system (SPS™) ensures precise printing results. Print jobs can be stored in a queue, started from the control panel and transmitted via Ethernet or WiFi. The printer can also operate as a wireless hot spot.

Technical data

Dimensions (W x D x H): 260 x 380 x 370 mm

Build volume (X, Y, Z): 119 x 67 x 75 mm

Consistent data formats: STL, SLC, STM

Image technology: DLP

Pixel size: 62 µm

Light source: UV LED projector with HD chip

Wavelength: 385 nm

Voltage source: 100 - 240 V, 50/60 Hz

Power: 500 W

/// Asiga MAX™

6501.1
1 piece

Entry-level printer with LCD technology

Asiga MAX™ LCD

The Asiga MAX™ LCD combines the ease-of-operation of the Asiga MAX™ with proven and economic LCD technology. The pixel matrix used for this printer is the LCD display with LED backlight. This technology is cost-effective, yet precise and reliable, turning the printer into an attractive entry-level printer.

Technical data

Dimensions (W x D x H): 260 x 380 x 370 mm

Build volume (X, Y, Z): 121 x 68 x 76 mm

Consistent data formats: STL, SLC, STM

Image technology: LCD

Pixel size: 47 µm

Light source: LED

Wavelength: 405 nm

Voltage source: 100 - 240 V, 50/60 Hz

Power: 500 W

// Asiga MAX™ LCD

6530.1
1 piece



Asiga MAX™ Tray

The tray system of the Asiga MAX™ allows for easy changing and refilling of materials. Four trays with maximum print capacity of 1l, 2l, 5l or 10l and a maximum fill level of 300 to 400 ml per application are available. Equipped with RFID chip for recording the object volume generated during the print job. It is not possible to use the tray exceeding the maximum print volume.

// 2l

6515.1
1 piece

// 1l

6516.1
1 piece

// 5l

6517.1
1 piece

// 10l

6518.1
1 piece

New

Asiga PRO HD

The Asiga PRO HD is a large format floor-standing 3D printer which combines proven industry-leading precision and a large build envelope with high-speed print capability for high printing volumes. It is equipped with 385 nm DLP technology and a high power UV LED light source, featuring CNC machined calibration assembly, SPST™ Smart-Positioning-System technology and process monitoring technologies for repeatable precision and accurate layer formation. Various ease-of-operation features like Asiga Composer software, touch screen display, simple user interface, Wifi and remote control via web interface are included as well.

Asiga PRO HD is available in three versions that differ in pixel resolution (65, 80 or 100 μm) and thus build volume.

Technical data

Image technology: DLP

Light source: high power UV LED projector with HD chip

Wavelength: 385 nm

Pixel size: 65, 80 or 100 μm

Build volume (X, Y, Z): 125 x 70 x 200 mm (Asiga PRO HD65) /
153.6 x 86.4 x 200 mm (Asiga PRO HD80) /
192 x 108 x 200 mm (Asiga PRO HD100)

Layer thickness: 10-150 (continuous adjustment with accuracy of 1 μm)

File input: STL, SLC, STM

Voltage source: 100 - 240 V, 50/60 Hz

Power: 500 W

Dimensions (D x W x H): 420 x 465 x 1370 mm

Weight: 75 kg

/// Asiga PRO HD65	6535.1 1 piece
/// Asiga PRO HD80	6536.1 1 piece
/// Asiga PRO HD100	6537.1 1 piece



New

Asiga PRO 4K

Asiga PRO 4K is a floor-standing 3D printer utilizing the latest DLP imaging technology and combining precision, reliability and speed for high print volumes in the most demanding production applications. Compared to Asiga PRO HD, this model is equipped with a 4K projector, allowing even larger build volumes at the same pixel resolution. Besides the proven SPS™ Smart Positioning System and various technologies for process monitoring, Asiga PRO 4K offers familiar ease-of-operation features like Asiga Composer software, touchscreen display, simple user interface, WiFi and remote control via web interface.

Asiga PRO 4K is available in two versions that differ in pixel resolution (65 or 80 µm) and thus build volume.

Technical data

Image technology: DLP

Light source: high power UV LED projector with 4K chip

Wavelength: 385 nm

Pixel size: 65 or 80 µm

Build volume (X, Y, Z): 176 x 99 x 200 mm (Asiga PRO 4K65) /
217 x 122 x 200 mm (Asiga PRO 4K80)

Layer thickness: 10 -150 (continuous adjustment with accuracy of 1 µm)

File input: STL, SLC, STM

Voltage source: 100 - 240 V, 50/60 Hz

Power: 500 W

Dimensions (D x W x H): 420 x 465 x 1370 mm

Weight: 75 kg

/// Asiga PRO 4K65

6538.1
1 piece

/// Asiga PRO 4K80

6539.1
1 piece





New

IMPRIMO® Clean

Cleaning unit for gentle cleaning of 3D printed objects. The IMPRIMO® Clean creates a circular flow in the cleaning solution to minimize the risk of micro-cracks in the part surface, thus increasing its quality. Different cleaning programs allow for precise matching with the selected material class and choice of the cleaning agent. The easy removable insert enables quick and clean replacement of the cleaning solution. The cleaning unit will be able to communicate with an app via a wireless network, to allow for complete documentation of the cleaning process.

Technical data

Voltage: 100 - 230 V
 Dimensions: 404 x 404 x 240 mm
 Cleaning chamber: 140 x 140 x 100 mm (3,5 l capacity)
 Software: Linux OS
 Network compatibility: Wifi, Ethernet
 Touch panel: 7"

IMPRIMO® Clean

6534.1
1 piece

With protective gas (nitrogen)

IMPRIMO® Cure

Light oven for the polymerization of 3D printed objects with LED exposure technology and protective gas device (nitrogen), avoiding the formation of an inhibition layer. Control of exposure parameters via touch screen. Built-in sensors measure the protective gas flow in the polymerization chamber and inform the user about the state of the light source. Communication of the Light Oven with an app via a wireless network will be possible for the transmission of QM relevant data such as exposure programs.

IMPRIMO® Cure

6532.1
1 piece



Technical data

Voltage: 220 V
 Wavelength: 365 / 405 nm
 Light source: LED
 Dimensions: 405 x 210 x 430 mm
 UV-chamber: 167 x 115 x 105 mm
 Network compatibility: Wifi
 Sensor: gas pressure, UV sensor
 Working pressure: 1.8 bar

Light curing

Learn more:



LC-6 Light Oven

High-capacity light polymerisation unit for up to 4 models and fixator. Its inner dimensions of 170 x 160 x 120 mm (W x D x H) offer enough space for articulated and mounted models. Six fluorescent light tubes (3 UVA and 3 blue light tubes) and an aluminium reflector guarantee homogeneous illumination. Two polymerisation times of 5 and 10 minutes are already pre-set in accordance with the light-curing DURASPLINT® LC material. Continuous operation can also be set. Spectral range of the light curing device between 350 and 450 nm. Auto start function for easier application.

Technical data

Voltage: 230/115 V

Dimensions (W x H x D): 240 x 180 x 270 mm

Weight: 3 kgs

3 years warranty, 10 years warranty on availability of spare parts

// 230 V

5610.1
1 piece

// 115 V

5620.1
1 piece



LC-Mini Light

LED curing light with 14 LEDs designed for fixation and initial polymerisation of DURASPLINT® LC and CLEAR-BLOKKER®. Ideal for fixing fastening parts of IST® or OPM devices in combination with the LC primer. Final light polymerisation in stationary light curing unit such as LC 6 Light Oven. Use with customary AAA batteries.

Technical data

Wavelength: 400 - 405 nm

Weight (without batteries): 96 g

Length (without shade): 120 mm

// LC-Mini Light
with shade

5606.1
1 piece



Metal support for LC Mini Light

Powder-coated metal support to which the LC Mini Light can be easily attached in its circumferential grooves. Facilitates the polymerization of light curing materials such as BLUE-BLOKKER® or the positioning of IST® fastening elements directly below the light cone.

Dimensions (W x H x D): 70 x 200 x 127 mm

// Metal support for LC Mini Light

5607.1
1 piece



Pressure moulding technique

Learn more:



BIOSTAR®

Versatile pressure moulding machine for all applications in dental pressure moulding and orthodontics, equipped with scan technology and 6.0 bar working pressure, adjustable by pressure reducing valve on the unit. The unique thermally controlled infrared heater reaches working temperature in one second. All parameters such as temperature, heating and cooling times are programmed by reading the scanner or entering the corresponding code. The coloured 3.2" LCD display with a resolution of 320 x 240 pixel leads you through the single working steps of the pressure moulding process, providing further information on scanned material, its indication as well as a library with illustrated application hints for fabrication. Rear port for easy updates. Large model cup facilitates embedding of mounted models. Pellet container ensures optimum dispensing and storing of pellets.

Technical data

Voltage / power: 230/115/100 V, 750 W
 Working pressure: 0.5 - 6.0 bar
 Dimensions: (W x H x D): 520 x 240 x 440 mm
 Weight: 14 kgs
 3 years warranty, 10 years warranty on availability of spare parts

/// 230 V	3001.1 1 piece
/// 115 V	3011.1 1 piece
/// 100 V	3021.1 1 piece

BIOSTAR® Protection cover

Made of transparent plastic, avoids soiling.

/// BIOSTAR® Protection cover

3449.1
1 piece





MINISTAR S®

The compact pressure moulding unit MINISTAR S® equipped with scanning technology: scanner reads the coded material, allowing programming of all important parameters such as heating time, temperature and cooling time. Precise pressure moulding results are reached in record time thanks to the extremely fast, patented heater and working pressure of 4.0 bar, adjustable via pressure regulator. Equipped with user-friendly membrane keypad and large display which indicates and monitors all operating parameters.

Technical data

Voltage / power: 230/115/100 V, 750 W

Working pressure: 0.5 - 4.0 bar

Dimensions (W x H x D): 500 x 210 x 400 mm

Weight: 9 kgs

3 years warranty, 10 years availability of spare parts

// 230 V	3501.1 1 piece
// 115 V	3511.1 1 piece
// 100 V	3521.1 1 piece

MINISTAR S® Protection cover

Made of transparent plastic, avoids soiling.

// MINISTAR S® Protection cover

3447.1
1 piece



Auxiliaries

Model holder

With flexible clamps and movable joints, keeps small and large models fixed in any required position.

// Model holder

5270.1
1 piece



Parallelometer

Indispensable auxiliary instrument when fabricating precise adjusted splints. The parallelometer enables determination of insertion direction and marking of tooth equator. The extensions of DURAN® splints, built-up with DURASPLINT® LC, should not exceed the tooth equator to avoid cracks or fissures when inserting or removing the splint.

Includes measurement accessories:

Guiding pin

Wax scraper

Cone

Measurement instrument (0.25 mm diameter)

Measurement instrument (0.50 mm diameter)

Measurement instrument (0.75 mm diameter)

// Parallelometer
incl. model holder, graphite leads and measurement accessories

5362.1
1 piece



Split-Fixator

Stable occlusal holder with sliding arms. By unscrewing the centring tips, models can be removed without any damage and reinserted at any time in exactly the same position. Precise dovetailed guidance avoids twisting of fixator arms.

// Split-Fixator

5380.1
1 piece



Hinge fixator

Thanks to the hinge in the upper part of the fixator, grinding of functional orthodontic appliances and fabrication of bimaxillary appliances becomes easier. Mounting splints on fixator arms ensure easy removal and precise repositioning of models.

// Hinge fixator

5374.1
1 piece

// peaked screws

5376.1
10 pieces



Mounting rails

Suitable for hinge fixator.

// Mounting rails

5375.1
10 pieces



Indication Chart on Applications in the Pressure Moulding Technique

Indication	Product	Recommended Thickness
Anti-snoring splint	DURAN®	2.0 mm
	DURAN®+	2.0 mm
	DURASOFT® pd with DURASOFT® seal	1.8 / 2.5 mm
Bite taking / Bite registration	IMPRELON® white, clear	2.0 / 3.0 mm
Bleaching splint	BIOPLAST® bleach	1.0 mm
	COPYPLAST®	1.0 mm
Bracket transfer mask	COPYPLAST®	0.5 / 0.75 mm
Copings	HARDCAST®	0.4 / 0.6 / 0.8 mm
Cosmetic splint	DURAN®+ A2	0.5 - 0.75 mm
	DURAN®+ white pd	0.5 - 1.0 mm
Etching mask	COPYPLAST®	1.0 mm
Fluorisation splint	DURAN®	1.0 / 1.5 mm
	DURAN®+	1.0 / 1.5 mm
Foil for therapy planning / analysis of bruxism	BRUX CHECKER®	0.1 mm
Immediate Dentures / temporary dentures	BIOCRYL® C (rose or clear)	2.0 / 3.0 mm
Individual impression tray, functional tray	IMPRELON® (clear)	2.0 / 3.0 mm
	IMPRELON® (opaque)	3.0 mm
Insulation Foil	ISOFOLAN®	0.1 mm
Invisible Retainer / Orthodontic splint	DURASOFT® pd with DURASOFT® seal	1.2 mm
	DURAN®	0.4 - 1.0 mm
	DURAN®+	0.4 - 1.0 mm
	IMPRELON®S pd	0.5 - 1.0 mm
	COPYPLAST® C	1.0 mm
Medical tray	DURAN®	1.0 mm
	DURAN®+	1.0 mm
Model duplication	BIOPLAST® (plaster)	min. 3.0 mm
	COPYPLAST® (resin)	2.0 mm
Model protection / Protective coating / Skin-packaging	Coating Foil	0.15 mm
Moulds for temporary crowns and bridges	COPYPLAST®	0.5 - 2.0 mm
Mouth Guard, sports protection	BIOPLAST®	1.0 - 5.0 mm
	BIOPLAST® XTREME / XTREME PRO	4.0 / 5.0 mm
Occlusal splint / Bruxism splint / Miniplast splint	DURAN®	1.0 - 1.5 mm
	DURAN®+	1.0 - 1.5 mm
	DURASOFT® pd optional with DURASOFT® seal	1.8 mm
OSAMU-Retainer® (combination BIOPLAST® and IMPRELON®S pd)	BIOPLAST®	1.5 mm
	IMPRELON®S pd with OSAMU-Bond	0.75 mm
Positioner	BIOPLAST®	2.0 - 5.0 mm
Retainer / Orthodontic plates	BIOCRYL® C	2.0 / 3.0 mm for lower jaw
Radiopaque splints	BIOCRYL® Form X	1.5 mm
Retention splint / Long-term retainer	COPYPLAST® C	1.0 mm
	DURAN®	0.75 / 1.0 mm
	DURAN®+	0.75 / 1.0 mm
	IMPRELON®S pd	0.75 / 1.0 mm
Spacer maintainer foil for copings	Spacer foil	0.1 mm
Spacer maintainer for bleaching splints	HARDCAST®	0.4 / 0.6 / 0.8 mm
Template for implants / Drillings / X-ray	DURAN®	2.0 / 3.0 mm
	DURAN®+	2.0 mm
Temporary Splint / Strip crown for temporary crowns and bridges	DURAN®	0.5 - 1.0 mm
	DURAN® +A2 pd	0.5 - 0.75 mm

Material Qualities	Bonds to Acrylic	Recommended Acrylic	Recommended Insulation
hard-elastic	yes	DURASPLINT®/ DURASPLINT® LC	ISOFOLAN® foil
hard-elastic	yes	DURASPLINT®/ DURASPLINT® LC	
hard / soft	yes	DURASPLINT®	ISOFOLAN® foil
hard / not elastic	yes	DURASPLINT®	ISOFOLAN® foil
soft-elastic	no		BIOPLAST® Insulating agent / soak model into water *
viscoplastic	no		Soak model shortly into water or spacer maintainer foil*
viscoplastic	no		Soak model shortly into water or spacer maintainer foil
viscoplastic	no		Spacer foil
hard-elastic	yes	veneering material	
hard-elastic	yes	veneering material	
viscoplastic	no		Soak model shortly into water or spacer foil
hard-elastic	yes		BIOPLAST® (space maintainer)
hard-elastic	yes		BIOPLAST® (space maintainer)
impact-resistant	yes	BIOCRYL® RESIN	ISOFOLAN® foil
hard / not elastic	yes	DURASPLINT®	ISOFOLAN® foil or Foam Discs
hard / not elastic	yes	DURASPLINT®	ISOFOLAN® foil or Foam Discs
viscoplastic insulation foil	no		
hard / soft	yes	DURASPLINT®/ DURASPLINT® LC	ISOFOLAN® foil
hard-elastic	yes	DURASPLINT®/ DURASPLINT® LC	ISOFOLAN® foil
hard-elastic	yes	DURASPLINT®/ DURASPLINT® LC	
hard-elastic / impact-resistant	not recommended		ISOFOLAN® foil
viscoplastic	no		Soak model shortly into water or spacer foil
hard-elastic	yes	DURASPLINT®/ DURASPLINT® LC	ISOFOLAN® foil
hard-elastic	yes	DURASPLINT®/ DURASPLINT® LC	
soft-elastic	no		BIOPLAST® Insulating agent / soak model into water
viscoplastic	no		Soak model shortly into water or spacer foil
bonds to Skin cardboard			
viscoplastic	no		Soak model shortly into water or spacer foil
soft-elastic	no		BIOPLAST® insulating agent
soft-elastic	no		BIOPLAST® insulating agent
hard-elastic	yes	DURASPLINT® / DURASPLINT® LC	ISOFOLAN® foil
hard-elastic	yes	DURASPLINT® / DURASPLINT® LC	
hard / soft	yes	DURASPLINT®	ISOFOLAN® foil
soft-elastic	no		BIOPLAST® insulating agent
hard-elastic / impact-resistant	no		
soft-elastic	no		BIOPLAST® insulating agent
impact-resistant	yes	BIOCRYL® RESIN	ISOFOLAN® foil
viscoplastic	no		Spacer maintainer foil
viscoplastic	no		Soak model shortly into water or spacer foil
hard-elastic	yes	DURASPLINT®/ DURASPLINT® LC	ISOFOLAN® foil
hard-elastic	yes	DURASPLINT®/ DURASPLINT® LC	
hard-elastic / impact-resistant	not recommended		ISOFOLAN® foil
hard insulation foil	yes		
viscoplastic	no		Spacer foil
hard-elastic	yes	DURASPLINT®/ DURASPLINT® LC	ISOFOLAN® foil
hard-elastic	yes	DURASPLINT®/ DURASPLINT® LC	
hard-elastic	yes	veneering material	ISOFOLAN® foil
hard-elastic	yes	veneering material	

* BLUE-BLOKKER as space maintainer/reservoir

Technical properties of IMPRIMO® LC resins

Property	Standard	IMPRIMO® LC			
		Model	Splint	Impression	Cast
Colour		ivory, grey, beige	transparent	orange	red
Density		1.1 g/ml	1.1 g/ml	1.1 g/ml	1.1 g/ml
Flexural strength	ISO 178	108 MPa	93 MPa	84 MPa	86 MPa
	ISO 10477				
	ISO 4049				
	ISO 20795-1				
	ISO 20795-2		64 MPa*		
Tensile strength	DIN 53504				
	DIN 53505				
Elongation at break	ISO 178	5.00 %	10.00 %	10.00 %	5.00 %
	DIN 53505				
	DIN 53504				
Flexural modulus	ISO 20795-1				
E-modulus	ISO 178	2,327 MPa	2,121 MPa	1,776 MPa	1,791 MPa
	ISO 20795-2		1,584 MPa*		
Shore hardness	ISO 7619-1	85D	80D	80D	85D
Viscosity (23°C)	DIN 53019-1	0.7 Pa s	0.7 Pa s	0.7 Pa s	0.3 Pa s
Solubility	ISO 4049				
	ISO 20795-1				
	ISO 20795-2		1.4 µg mm ⁻³		
Water absorption	ISO 4049				
	ISO 20795-1				
	ISO 20795-2		24 µg mm ⁻³		
Colour stability	ISO 4049				
	ISO 10477				
Biocompatibility: irritation and delayed-type allergies	ISO 10993-10		comply	comply	
Biocompatibility: genotoxicity, carcinogenicity and toxicity for reproduction	ISO 10993-3		comply	comply	
Biocompatibility: systemic toxicity	ISO 10993-11		comply	comply	
Biocompatibility: cytotoxicity	ISO 10339-5		comply	comply	
Biocompatibility: hemocompatibility	ISO 10993-4				

Building material

IMPRIMO® LC IBT	IMPRIMO® LC Gingiva	IMPRIMO® LC Temp	IMPRIMO® LC Temp It	IMPRIMO® LC MJF	IMPRIMO® LC Denture	IMPRIMO® LC Try-In
transparent	rose	A1, A2, A3 (Vita classical)	A1, A2, A3 (Vita classical)	transparent	orange pink, light pink, deep pink	A1, A2, A3 (Vita classical)
1.1 g/ml	1.1 g/ml	1.2 g/ml	1.4 g/ml	1.1 g/ml	1.1 g/ml	1.1 g/ml
		113 MPa	169 MPa	117 MPa	114 MPa	91 MPa
		91 MPa				
			112 MPa			
					84 MPa*	
				80 MPa		
6.2 MPa						
	5 MPa					
		4,00%	4,00%	5,00%	8,00%	8,00%
	90.00 %					
50.00 %						
					2,383 MPa*	
		2,442 MPa	5,528 MPa	2,508 MPa	2,438 MPa	2,028 MPa
				1,668 MPa		
40D	50A	80D	80D	85D	85D	80D
2.5 Pa s	2.5 Pa s	1.5 Pa s	3.5 Pa s	0.7 Pa s	0.5 Pa s	0.7 Pa s
		1.1 µg mm-3	1.1 µg mm-3			
					0.41 µg mm-3	
					0.51 µg mm-3	
		31.1 µg mm-3	31.1 µg mm-3			
					≤ 25.8 µg mm-3	
				19.9 µg mm-3		
		≤ 1.5	≤ 1.5			
					≤ 2.5	
comply		comply	comply	comply	comply	comply
		comply	comply	comply	comply	comply
		comply	comply	comply	comply	comply
comply		comply	comply	comply	comply	comply
				comply		

* based on the standard

Expansion parameters of VECTOR® screws

Expansion screw	REF	Expansion per 1/1 turn frontal / transversal	Expansion per ¼ turn frontal / transversal	Total expansion fontal / transversal
VECTOR® 30	2484	0.35 mm	0.0875 mm	3.0 mm
VECTOR® 40	2486	0.7 mm	0.175 mm	3.0 mm
VECTOR® 45	2487	0.7 mm	0.175 mm	3.0 mm
VECTOR® 50	2489	0.7 mm	0.175 mm	3.0 mm
VECTOR® 80	2490	0.8 mm	0.2 mm	7.0 mm
VECTOR® 90	2491	0.7 mm	0.175 mm	4.0 mm
VECTOR® 100	2492	0.7 mm	0.175 mm	5.0 mm
VECTOR® 140	2494	0.8 mm	0.2 mm	5.0 mm
VECTOR® 160	2496	0.8 mm	0.2 mm	6.0 mm
VECTOR® 190	2497	0.8 mm	0.2 mm	5.0 mm
VECTOR® 200	2498	0.8 mm	0.2 mm	7.5 mm
VECTOR® 350	2509	0.35 mm	0.0875 mm	4.0 mm
VECTOR® 400	2510	0.35 mm	0.0875 mm	3.0 mm
VECTOR® 420	2512	0.35 mm	0.0875 mm	5.0 mm
VECTOR® 440	2514	0.35 mm	0.0875 mm	5.0 mm
VECTOR® 440R	2513	0.35 mm	0.0875 mm	5.0 mm
VECTOR® 460	2516	0.4 mm	0.1 mm	5.0 mm
VECTOR® 500	2520	0.35 mm	0.0875 mm	3.0 mm
VECTOR® 520	2522	0.35 mm	0.0875 mm	5.0 mm
VECTOR® 600	2524	0.9 mm	0.225 mm	9.0 mm
VECTOR® 620	2526	0.9 mm	0.225 mm	11.0 mm
VECTOR® 720	2530	0.8 / 0.4 mm	0.2 / 0.1 mm	5.5 / 7.0 mm
VECTOR® 730	2532	0.4 mm	0.1 mm	5.5 / 2 x 3.5 mm
VECTOR® 740	2540	0.7 / 0.35 mm	0.175 / 0.0875 mm	2.5 / 5.0 mm
VECTOR® 750	2542	0.35 mm	0.0875 mm	2.5 / 2 x 2.5 mm
VECTOR® 800	2533	0.8 mm	0.2 mm	9.0 mm
VECTOR® 820	2534	0.8 mm	0.2 mm	11.0 mm
VECTOR® 900	2536	0.7 mm	0.175 mm	5.0 mm
VECTOR® Piston screw, 4 mm	2477	0.35 mm	0.0875 mm	up to 7.0 mm
VECTOR® Piston screw, 6 mm	2478	0.35 mm	0.0875 mm	
VECTOR® Piston screw, 8 mm	2479	0.35 mm	0.0875 mm	

Material list of alloys used by SCHEU-DENTAL (Analysis in Weight-%)

Material	DIN-no.	C	Si	Mn	Cr	Mo	Ni	P	S	Others	Fe	Product Name Product Group
stainless steel	1.4021	0.16 – 0.25	≤ 1.0	≤ 1.5	12.0 – 14.0			≤ 0.040	≤ 0.015			CARAT® / CA®-pliers
stainless steel	1.4116	0.43 – 0.5	≤ 1.0	≤ 1.0	12.5 – 14.5			≤ 0.040	≤ 0.015			CA®-pliers
stainless steel	1.4301	≤ 0.07	≤ 1.0	≤ 2.0	17.5 – 19.5		8 – 10.5	≤ 0.045	≤ 0.015	N ≤ 0.11	rest	SCHEU-Anchor, Clasps/Bars
stainless steel	1.4303	≤ 0.06	≤ 1.0	≤ 2.0	17.0 – 19.0		11.0 – 13.0	≤ 0.045	≤ 0.015	N ≤ 0.11	rest	PROFI-Bar
stainless steel	1.4305	≤ 0.10	≤ 1.0	≤ 2.0	17.0 – 19.0		8.0 – 10.0	≤ 0.045	0.15 – 0.35	N ≤ 0.11 CU ≤ 1.0	rest	Hinge 44, Hinge system acc. to Herbst
stainless steel	1.4310	0.05 – 0.15	≤ 2.0	≤ 2.0	16.0 – 19.0	≤ 0.8	6.0 – 9.5	≤ 0.045	≤ 0.015		rest	CHROMIUM Preformed Wires
stainless steel	1.4456	≤ 0.1	≤ 1.0	16.0 – 20.0	16.0 – 20.0	1.8 – 2.5	≤ 0.2	≤ 0.050	≤ 0.05	V ≤ 0.2 N 0.7 - 1.0	rest	MENZANIUM®
stainless steel	1.4435	≤ 0.03	≤ 1.0	≤ 2.0	17 – 19	2.5 – 3	12.5 – 15	≤ 0.045	≤ 0.015	N ≤ 0.11		TAP® Standard

Material	Co	Ni	Fe	MN	Cr	Mo	Ti	Si	C	Al	O	H	N	V	Cu	Nb	Product Name Product Group
Titan Grade 5			≤ 0.4	≤ 0.1			Rest		≤ 0.08	5.5 – 6.75	≤ 0.2	≤ 0.015	≤ 0.05	3.5 – 4.5			TAP®-T / TAP®-T Reverse Upper protrusion adjustment device
CrCo	62.0 – 66.0				27.0 – 31.0	4.0 – 5.0											TAP®-T Lower guiding device

Measurement units

mm	Inch	° C	° F	DIN-No.	Material-Name	AISI	UNS
0.10	0.004	10	50	1.4021	X20Cr13	420	S42000
0.15	0.006	25	77	1.4034	X46Cr13	420C	
0.40	0.016	50	122	1.4116	X50CrMoV 15		
0.5	0.020	75	167	1.4035	X46CrS13	420F	
0.6	0.024	100	212	1.4301	X5CrNi18-10	304	S30400
0.625	0.025	125	257	1.4303	X4CrNi18-12	305	S30500
0.75	0.030	150	302	1.4305	X8CrNiS18-9	303	S30300
0.8	0.031	180	356	1.4310	X10CrNi18-8	301	S30100
1.00	0.0394	190	374	1.4456	X8CrMnMoN18-18-2		
1.15	0.045	200	392				
1.30	0.051	210	410				
1.50	0.059	220	428				
2.00	0.079	250	482				
3.00	0.118	280	536				
4.00	0.157	300	572				
5.00	0.197	350	662				
25.40	1.00	400	752				
				bar	at	N / mm²	p.s.i.
				1	≈ 1.02	≈ 0.1	14.504
				2	≈ 2.04	≈ 0.2	29.008
				3	≈ 3.06	≈ 0.3	43.511
				4	≈ 4.08	≈ 0.4	58.015
				5	≈ 5.10	≈ 0.5	72.519
				6	≈ 6.12	≈ 0.6	87.023
				7	≈ 7.14	≈ 0.7	101.526

Product Index

REF	Product	Page
1002	O-Clasp	18
1003	O-Clasp	18
1007	OK-Clasp	18
1009	N-Clasp	18
1010	N-Clasp	18
1011	N-Clasp	18
1012	N-BI-Form-Clasp	18
1013	NK-Clasp	18
1017	J-Clasp	19
1018	J-Clasp	19
1019	J-Clasp	19
1020	J-Clasp oblique	20
1021	J-Clasp oblique	20
1022	J-Clasp oblique	20
1023	JM-Clasp	20
1026	T-Clasp	19
1027	T-Clasp	19
1029	TK-Clasp	19
1030	TK-Clasp	19
1038	Jaw fracture splint	21
1039	PROFI Bar	21
1040	PROFI Bar	21
1047	J-Clasp	19
1048	J-Clasp oblique	20
1049	Jaw fracture splint	21
1051	Lingual bar	21
1052	Lingual bar	21
1053	Lingual bar	21
2040	CARAT® Crampon pliers	30
2041	CARAT® Flat pliers	29
2042	CARAT® Young pliers	30
2043	CARAT® Angle pliers (HM)	29
2044	CARAT® Aderer pliers large	29
2046	CARAT® Aderer pliers medium	29
2048	SCHEU-Anchor	20
2049	SCHEU-Anchor	20
2050	SCHEU-Anchor	20
2051	SCHEU-Anchor	20
2052	SCHEU-Anchor	20
2053	SCHEU-Anchor	20
2055	Arrow Clasp	25
2056	Arrow Clasp	25
2100	Security key for expansion screws	37
2101	Key for expansion screws	37
2104	Adams Clasp	24
2105	Adams Clasp	24
2106	Adams Clasp	24
2107	Adams Clasp	24
2108	Adams Clasp	24

REF	Product	Page
2109	Adams Clasp	24
2118	U-Bar acc. to Karwetzky	25
2119	Face bow polished	46
2288	Triangle Clasp	24
2322	Triangle Clasp	24
2329	Frontal guiding bars acc. to Hinz	25
2330	Frontal guiding bars acc. to Hinz	25
2331	Positioning aid	47
2332	Angle tester acc. to Adamik	47
2419	Coffin spring	25
2434	Activator tubes acc. to Teuscher	45
2436	Activator tubes acc. to Teuscher	45
2439	Face bow polished	46
2450	ORTHOFT® Anatomic	46
2451	ORTHOFT® Anatomic	46
2470	Activator tubes	45
2471	Activator tubes	45
2472	Activator tubes	45
2477	VECTOR® Piston screw	36
2478	VECTOR® Piston screw	36
2479	VECTOR® Piston screw	36
2480	Mounting screw	37
2481	Serrated housing nut	37
2482	Reamer	37
2483	Screwdriver F	37
2484	VECTOR® 30	31
2486	VECTOR® 40 acc. to Prof. Hinz	31
2487	VECTOR® 45 acc. to Prof. Hinz	31
2489	VECTOR® 50	32
2490	VECTOR® 80	32
2491	VECTOR® 90	32
2492	VECTOR® 100	32
2494	VECTOR® 140	32
2496	VECTOR® 160	32
2497	VECTOR® 190	33
2498	VECTOR® 200	33
2509	VECTOR® 350	33
2510	VECTOR® 400	33
2512	VECTOR® 420	33
2513	VECTOR® 440R	34
2514	VECTOR® 440	33
2516	VECTOR® 460	34
2520	VECTOR® 500	34
2522	VECTOR® 520	34
2524	VECTOR® 600	34
2526	VECTOR® 620	34
2530	VECTOR® 720 acc. to Bertoni	35
2532	VECTOR® 730 acc. to Bertoni	35
2533	VECTOR® 800	36

REF	Product	Page
2534	VECTOR® 820	36
2537	VECTOR® 900	36
2540	VECTOR® 740 acc. to Bertoni	35
2542	VECTOR® 750 acc. to Bertoni	35
3001	BIOSTAR®	126
3006	Pellet cover	113
3007	Pellet cover	113
3011	BIOSTAR®	126
3021	BIOSTAR®	126
3134	Model platform	113
3136	Pellet brush	113
3147	BIOCRYL® C	98
3148	BIOCRYL® Form X	98
3149	BIOCRYL® C	98
3150	BIOCRYL® C	98
3151	BIOCRYL® C	98
3152	BIOCRYL® C	98
3153	BIOCRYL® C	98
3164	IMPRELON®	106
3166	BIOPLAST® Insulating agent	110
3168	IMPRELON®	106
3169	COPYPLAST®	107
3175	COPYPLAST®	107
3177	COPYPLAST®	107
3179	COPYPLAST®	107
3181	COPYPLAST®	107
3183	BIOPLAST®	102
3185	BIOPLAST®	102
3187	BIOPLAST®	102
3188	BIOPLAST®	102
3189	BIOPLAST® Insulating agent	110
3190	BIOPLAST® bleach	103
3194	HARDCAST®	107
3195	HARDCAST®	107
3200	HARDCAST®	107
3202	Spacer foil	108
3203	Coating foil	108
3206	Skin packaging	108
3207	ISOFOLAN®	108
3209	BRUX CHECKER® acc. to Prof. Sato	105
3211	Silicone tube	47
3214	Cutting bur	115
3216	Impression tray handles	112
3218	BIOCRYL® Resin	110
3220	Blocking-out putty	110
3221	BIOCRYL® Resin	110
3222	Stainless steel pellets	113
3226	BIOPERM® Trimmer	116
3236	CETRON® Care set	49

REF	Product	Page	REF	Product	Page	REF	Product	Page
3237	CETRON® Cleaning powder	48	3355	BIOPLAST® Color	103	3441	CA® Foil	56
3238	CETRON® Care spray	48	3356	BIOPLAST® Color	103	3442	SIL-KITT	109
3239	CETRON® Cleaning powder	48	3361	IMPRELON®	106	3443	SIL-KITT	109
3242	OSAMU-Retainer® Kit	106	3369	HM- Carbide cutter	115	3444	Foam discs	112
3246	OSAMU-Bond	112	3370	HM-Tricutter fine	115	3445	BIOPLAST® Color	103
3247	OSAMU Polisher	116	3371	POLYFIX	116	3447	MINISTAR S® Protection cover	127
3256	DURASPLINT® LC	111	3372	POLYFIX	116	3448	BIOPLAST® Color	103
3257	DURASPLINT®	110	3374	BIOPLAST®	102	3449	BIOSTAR® Protection cover	126
3258	DURASPLINT®	110	3376	DIMO®PRO SLIM	117	3452	Heating support	113
3259	DURASPLINT®	110	3377	Finishing bur	115	3460	SD-Foil scissors A	114
3261	DURASPLINT® LC	111	3378	Finishing set	114	3461	SD-Foil scissors B	114
3263	LC Primer	112	3380	DIMO®	116	3470	DURAN®	99
3265	LC-Bur	115	3381	DIMO®PRO	117	3472	DURAN®+	99
3266	LC Insulation	112	3382	DIMO®	116	3473	DURAN®+ white pd	100
3267	LC-Bur	115	3383	DIMO®	116	3474	DURAN®+ white pd	100
3268	LC-Bur	115	3384	DIMO®	116	3475	DURAN®+ white pd	100
3270	BIOPLAST®	102	3387	DURASOFT® pd	101	3476	DURAN®+ white pd	100
3271	BIOPLAST® Color	103	3388	DURASOFT® pd	101	3501	MINISTAR S®	127
3274	IMPRELON®	106	3390	BIOPLAST® Multicolor	104	3511	MINISTAR S®	127
3282	BIOPLAST® Color	103	3391	BIOPLAST® Multicolor	104	3521	MINISTAR S®	127
3283	BIOPLAST® XTREME Kit	105	3392	BIOPLAST® Multicolor	104	3610	DURASPLINT® flex	111
3284	BIOPLAST® XTREME Kit	105	3393	BIOPLAST® Multicolor	104	3611	DURASPLINT® flex	111
3285	BIOPLAST® XTREME Kit	105	3394	BIOPLAST® Multicolor	104	3612	DURASPLINT® flex	111
3286	BIOPLAST® XTREME	104	3395	BIOPLAST® Multicolor	104	3619	DURASPLINT® flex	81
3287	BIOPLAST® XTREME	104	3396	BIOPLAST® Multicolor	104	3620	DURASPLINT® flex	81
3288	BIOPLAST® XTREME	104	3397	BIOPLAST® Multicolor	104	3701	SD- Cyano Veneer Fast	94
3289	BIOPLAST® XTREME	104	3398	BIOPLAST® Multicolor	104	3703	SD- Pipettes	94
3292	BIOPLAST® XTREME PRO Kit	105	3399	BIOPLAST® Multicolor	104	3710	SD- Polishing paste	117
3293	BIOPLAST® XTREME PRO Kit	105	3400	BIOPLAST® Multicolor	104	3711	SD- Polishing paste	117
3294	BIOPLAST® XTREME PRO Kit	105	3403	COPYPLAST® C	107	3712	SD- Polishing brush	117
3295	BIOPLAST® XTREME	104	3405	CA® Foil	56	3713	SD- Felt wheel	117
3296	BIOPLAST® XTREME	104	3406	CA® Foil	56	3714	SD- Polishing mop for high gloss	117
3297	BIOPLAST® XTREME	104	3407	CA® Foil	56	5261	CLEAR- BLOKKER®	94
3298	BIOPLAST® XTREME	104	3409	DURAN®	99	5263	CA® Grinding set	66
3320	IMPRELON® S pd	106	3411	DURAN®	99	5266	Set- up plaster	42
3322	IMPRELON® S pd	106	3413	DURAN®	99	5268	Set- up wax rods	43
3324	IMPRELON® S pd	106	3415	DURAN®	99	5270	Model holder	128
3326	IMPRELON® S pd	106	3417	DURAN®	99	5274	CA® CHECKER	54
3328	IMPRELON® S pd	106	3419	DURAN®	99	5276	BLUE- BLOKKER®	42
3330	IMPRELON® S pd	106	3421	DURAN®	99	5277	Cannula	109
3337	DURASOFT® seal	102	3422	DURAN®+ A2 pd	100	5278	Cannula	109
3338	DURASOFT® seal	102	3423	DURAN®+ A2 pd	100	5281	CA® TIP 1	59
3339	DURASOFT® seal	102	3424	DURAN®+ A2 pd	100	5282	CA® Splint case for patients	65
3341	DURASOFT® pd	101	3426	DURAN®+	99	5283	CA® Splint bags	65
3342	DURASOFT® pd	101	3428	DURAN®+	99	5288	Diamond separating disc	43
3345	DURASOFT® pd	101	3430	DURAN®+	99	5290	CA® Coloured pencils	66
3347	DURASOFT® blue pd	101	3432	DURAN®+	99	5291	CA® TIP 2	59
3348	DURASOFT® blue pd	101	3434	DURAN®+	99	5292	CA® TIP 3	59
3352	BIOPLAST® Color	103	3436	DURAN®+	99	5295	CA® TIP 4	60
3353	BIOPLAST® Color	103	3438	CA® Retention foil pd	56	5298	CA® Book, volume 1	67
3354	BIOPLAST® Color	103	3440	CA® Retention foil pd	56	5299	CA® TIP 5	60

REF	Product	Page
5300	CA® Pipettes	66
5301	CA® Plastic buttons	66
5302	CA® Cyano Veneer Fast	66
5303	CA® Travel Case	65
5305	CA® Book, volume 1	67
5307	CA® Book Advanced, volume 2	67
5308	CA® FLASH	65
5309	CA® Book Advanced, volume 2	67
5311	CA® SMART 2D version 4.0	54
5313	Extension set (4.0) for CA® photo support	55
5314	Fixing block for height adjustment of CA® photo support	55
5315	CA® Photo support 4.0	54
5316	CA® Gauge	62
5317	CA® Arch CHROMIUM	57
5319	CA® Distalizer kit acc. to Dr. Echarri	58
5323	CA® TIP 6	60
5326	CA® Strip Opener	61
5327	CA® Strip Opener	61
5329	TFA-Kit acc. to Dr. Echarri	58
5330	CA® POWER GRIP MFM	64
5331	CA® POWER GRIP MDI	64
5332	CA® POWER GRIP DMI	64
5333	CA® POWER GRIP FALA	64
5334	CA® POWER GRIP FALI	64
5335	CA® POWER GRIP BUB	64
5336	CA® POWER GRIP BUM	64
5337	CA® POWER GRIP BUAS	64
5338	CA® POWER GRIP set	64
5339	CA® POWER GRIP BUAL	64
5340	CA® POWER GRIP holder	64
5341	ECHARRI PST Set	62
5342	CA® Stripping Tool	61
5343	CA® Stripping Tool	61
5344	CA® Stripping Tool	61
5345	CA® Stripping Tool	61
5346	CA® Stripping Tool	61
5347	CA® Stripping Tool	61
5348	CA® Stripping Tool	61
5349	CA® Stripping Tool	61
5350	CA® Stripping Tool	61
5351	CA® Stripping Tool	61
5352	CA® Stripping Tool	61
5353	CA® Stripping Tool	61
5354	CA® Stripping Tool	61
5358	Stainless steel holder	62
5359	Splint Remover	67
5361	CA® Model holder for photo support 4.0	55
5362	Parallelometer	128
5368	Set-up wax blocks	43
5371	Set-up trimmer	43
5372	Set-up manual saw	42

REF	Product	Page
5373	Saw blades	42
5374	Hinge fixator	129
5375	Mounting rails	129
5376	Hinge fixator	129
5379	Saw blades	42
5380	Split-Fixator	129
5435	Retainer boxes	49
5444	Telescopes	84
5449	Telescopes	84
5454	Telescopes	84
5455	Fastening elements for Herbst appliance	44
5456	Fastening elements for Herbst appliance	44
5457	Fastening elements for IST® and Herbst appliances	85
5458	Hexagon socket screws	85
5461	IST® Kit HF 9	84
5462	GEORGE GAUGE™ bite fork	93
5466	O-Rings for IST® appliance	85
5468	Fastening elements for IST® appliance	85
5469	Positioning aid for IST® (12° / 0°)	84
5470	Occlusion trainer	93
5471	GEORGE GAUGE™ bite registration set	93
5472	GEORGE GAUGE™ bite fork	93
5473	GEORGE GAUGE™ bite fork	93
5474	Bite Fix®	92
5475	Bite Fix®	92
5478	Hinge system acc. to Herbst	44
5479	Hinge system acc. to Herbst	44
5480	Hinge system acc. to Herbst	44
5481	Distance rings	44
5482	Distance rings	44
5483	Distance rings	44
5484	Distance rings	44
5485	Distance rings	44
5489	Fastening elements with retention	45
5490	Hinge 44 kit	45
5492	Bite Fix® Scan	92
5493	Bite Fix® Scan	92
5495	OPM Kit	85
5503	Bite Fix® One	92
5606	LC-Mini Light	125
5607	Metal support for LC Mini Light	125
5610	LC-6 Light Oven	125
5620	LC-6 Light Oven	125
6501	Asiga MAX™	70
6502	IMPRIMO® LC Model	76
6503	IMPRIMO® LC Splint	76
6504	IMPRIMO® LC Model	76
6505	IMPRIMO® LC Model	76
6506	IMPRIMO® LC Impression	76
6507	IMPRIMO® LC Cast	77
6508	IMPRIMO® LC IBT	77

REF	Product	Page
6509	IMPRIMO® LC Gingiva	77
6510	3D Model insulation	41
6512	OnyxCeph3™ CA® SMART 3D - clinic	81
6513	OnyxCeph3™ CA® SMART 3D - laboratory	81
6515	Asiga MAX™ Tray	71
6516	Asiga MAX™ Tray	71
6517	Asiga MAX™ Tray	71
6518	Asiga MAX™ Tray	71
6526	IMPRIMO® LC MJF	79
6527	IMPRIMO® LC Temp	78
6528	IMPRIMO® LC Temp	78
6529	IMPRIMO® LC Temp	78
6530	Asiga MAX™ LCD	71
6532	IMPRIMO® Cure	75
6533	IMPRIMO® Cleaning Liquid	74
6534	IMPRIMO® Clean	74
6535	Asiga PRO HD	72
6536	Asiga PRO HD	72
6537	Asiga PRO HD	72
6538	Asiga PRO 4K	73
6539	Asiga PRO 4K	73
6540	IMPRIMO® LC Denture	78
6541	IMPRIMO® LC Try-In	78
6542	IMPRIMO® LC Try-In	78
6543	IMPRIMO® LC Try-In	78
6544	IMPRIMO® LC Temp It	79
6545	IMPRIMO® LC Temp It	79
6546	IMPRIMO® LC Temp It	79
6547	IMPRIMO® LC Denture	78
6548	IMPRIMO® LC Denture	78
6561	IMPRIMO® LC Model	76
6562	IMPRIMO® LC Cast	77
7243	RESIMIX®	40
7244	RESIMIX®	40
7284	RESIMIX®	40
8010	Quad Helix	28
8011	Quad Helix	28
8020	Quad Helix	28
8021	Quad Helix	28
8030	Quad Helix	28
8031	Quad Helix	28
8080	Lingual/palatal sheath	28
8081	Lingual/palatal sheath	28
8130	STEADY-RESIN polymer	40
8131	STEADY-RESIN polymer	40
8134	STEADY-RESIN S	38
8135	STEADY-RESIN M	38
8136	STEADY-RESIN S+M	38
8137	STEADY-RESIN S+M	38
8138	Metal spray nozzles	41
8139	Metal spray nozzles	41

REF	Product	Page
8140	STEADY-RESIN VARIO	38
8141	Spray bottle	41
8144	Mica	40
8145	Mica	40
8146	Mica	40
8147	Mica	40
8148	Mica	40
8150	Mica	40
8151	Mica	40
8152	Mica	40
8293	CHROMIUM Wire rods	27
8294	CHROMIUM Wire rods	27
8297	CHROMIUM Wire rods	27
8306	CHROMIUM Wire rods	27
8307	CHROMIUM Wire rods	27
8308	CHROMIUM Wire rods	27
8311	CHROMIUM Wire rods	27
8312	CHROMIUM Wire rods	27
8313	CHROMIUM Wire rods	27
8314	CHROMIUM Wire rods	27
8323	CHROMIUM Coil wire	27
8324	CHROMIUM Coil wire	27
8325	CHROMIUM Coil wire	27
8326	CHROMIUM Coil wire	27
8327	CHROMIUM Coil wire	27
8328	CHROMIUM Coil wire	27
8329	CHROMIUM Coil wire	27
8330	CHROMIUM Coil wire	27
8331	CHROMIUM Coil wire	27
8332	CHROMIUM Coil wire	27
8333	CHROMIUM Coil wire	27
8334	CHROMIUM Coil wire	27
8335	CHROMIUM Coil wire	27
8336	CHROMIUM Coil wire	27
8338	CHROMIUM Coil wire	27
8339	CHROMIUM Coil wire	27
8350	STEADY-RESIN Neon monomer	39
8351	STEADY-RESIN Coloured monomer	39
8352	STEADY-RESIN Coloured monomer	39
8353	STEADY-RESIN Coloured monomer	39
8354	STEADY-RESIN Coloured monomer	39
8355	STEADY-RESIN Coloured monomer	39
8356	STEADY-RESIN Coloured monomer	39
8357	STEADY-RESIN Neon monomer	39
8358	STEADY-RESIN Neon monomer	39
8359	STEADY-RESIN Neon monomer	39
8360	STEADY-RESIN Neon monomer	39
8361	STEADY-RESIN Neon monomer	39
8364	Orthodontic insulating agent	41
8382	CHROMIUM Coil wire	27
8383	CHROMIUM Coil wire	27

REF	Product	Page
8431	Symmetry measurement gauge	47
8435	ECHARRI Template kit	67
8450	Ortho arch bender	30
8453	MENZANIUM® Coil wire	26
8454	MENZANIUM® Coil wire	26
8455	MENZANIUM® Coil wire	26
8456	MENZANIUM® Coil wire	26
8459	MENZANIUM® Coil wire	26
8460	MENZANIUM® Coil wire	26
8461	MENZANIUM® Coil wire	26
8462	MENZANIUM® Coil wire	26
8463	MENZANIUM® Coil wire	26
8464	MENZANIUM® Coil wire	26
8466	MENZANIUM® Coil wire	26
8467	MENZANIUM® Wire rods	26
8468	MENZANIUM® Wire rods	26
8469	MENZANIUM® Wire rods	26
8470	MENZANIUM® Wire rods	26
8471	MENZANIUM® Wire rods	26
8472	MENZANIUM® Wire rods	26
8473	MENZANIUM® Wire rods	26
8478	MENZANIUM® Wire rods	26
8480	MENZANIUM® Wire rods	26
8482	MENZANIUM® Wire rods	26
9000	TAP® Standard	86
9010	TAP® Front assembly	90
9012	TAP3® Closed hook	90
9013	TAP® Lingual bar	90
9014	TAP® Locator	91
9015	TAP® Cover plate	90
9016	TAP® Mounting device	90
9029	TAP®-T XL Lower guiding device	91
9030	TAP®-T	86
9031	TAP®-T Starter-Set	87
9032	TAP®-T Lower guiding device	91
9033	TAP®-T Upper protrusion adjustment device	91
9035	Activation key	94
9037	TAP®-T Matrix	89
9039	TAP®-T Mounting device	89
9050	TAP®-T Reverse	87
9051	TAP®-T Reverse Starter-Set	87
9053	TAP®-T Reverse Upper protrusion adjustment device	91
9060	dreamTAP™	88
9070	myTAP™	89
9072	AM Aligner	93
9073	TAP® PAP	88
9074	TAP® PAP lower tray	88
9082	TAP® Splint case for patients	89



Welcome to SCHEU-DENTAL

Exit 46
Iserlohn–Oestrich

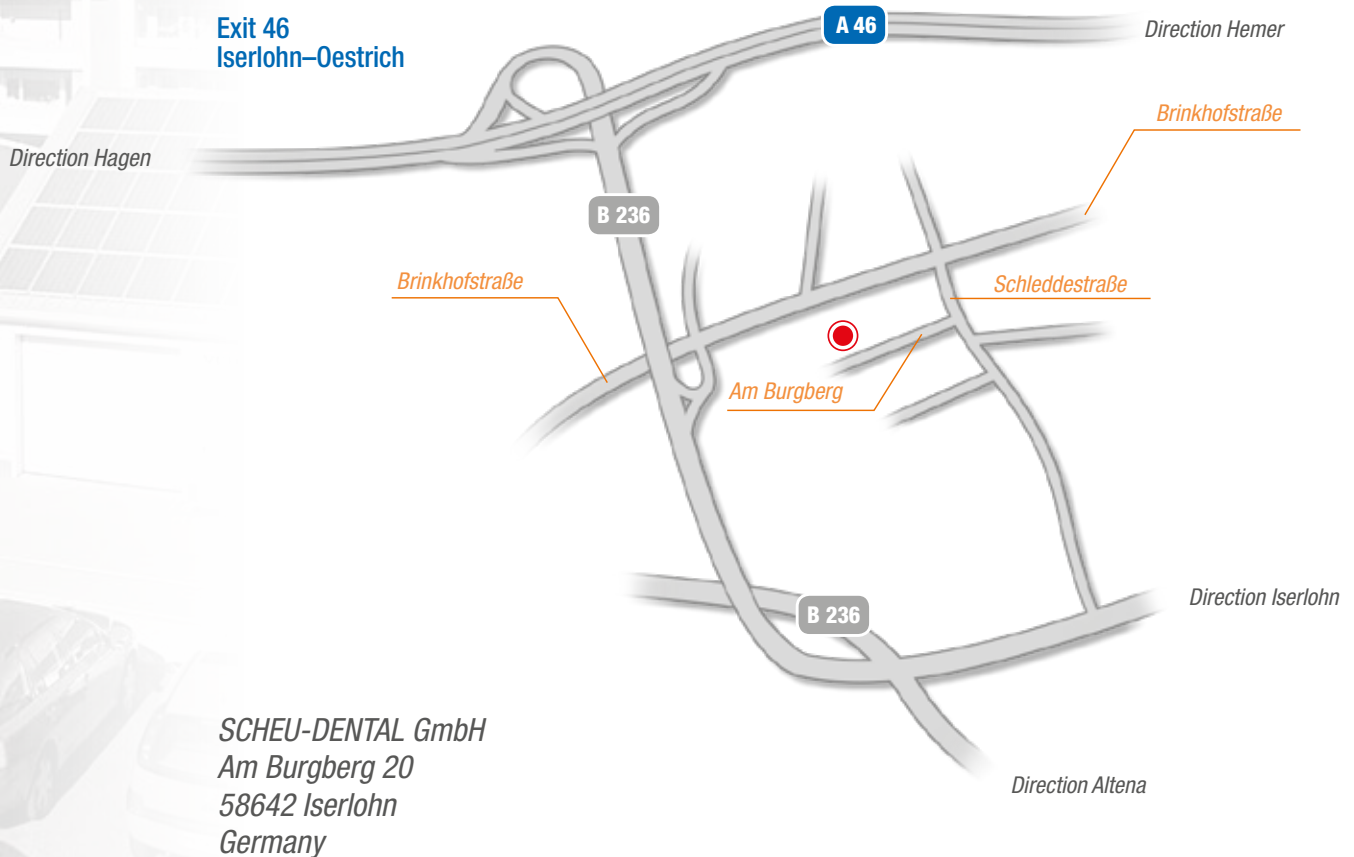

SCHEU-DENTAL GmbH
Am Burgberg 20
58642 Iserlohn
Germany

1. Motorway A45, at Hagener Kreuz
→ A46 Direction Iserlohn
2. Exit 46
→ Iserlohn – Oestrich
3. Please turn left after 200 m
→ Direction Oestrich
4. Please turn right at the roundabout
→ Gewerbegebiet Burgberg
5. Please turn right after 600 m
→ Schleddestraße
6. Please turn right immediately again
→ Am Burgberg

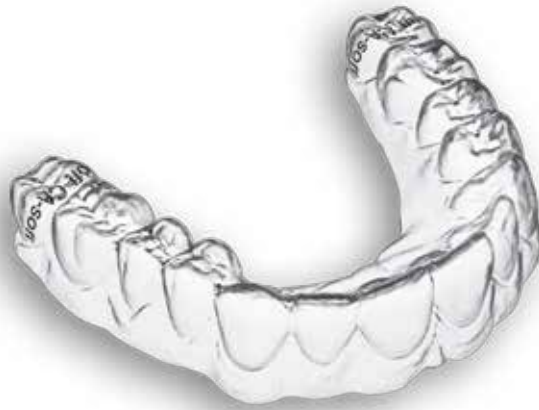

ALL GOOD THINGS COME IN THREES.

CA DIGITAL **_YOUR PARTNER FOR DIGITAL ORTHODONTIC TREATMENT**

CA DIGITAL's **CA® CLEAR ALIGNER** is simply three times as good:
3 innovative material thickness grades for up to 1 mm tooth movement per step, 3 steps per impression for more precise results - all of this online in just 3 clicks. Thanks to innovative software solutions, integrated workflows and advanced treatment options, CA DIGITAL is the right partner for all practices that intend taking the path to digitization. CA DIGITAL - your digital future is just a click away: www.ca-digit.com





More information:

SCHEU-DENTAL GmbH
www.scheu-dental.com

phone +49 2374 9288-0
fax +49 2374 9288-90

Am Burgberg 20
58642 Iserlohn · Germany



GB 4.500/08/19 S REF 0100.02

